

The skin of the city

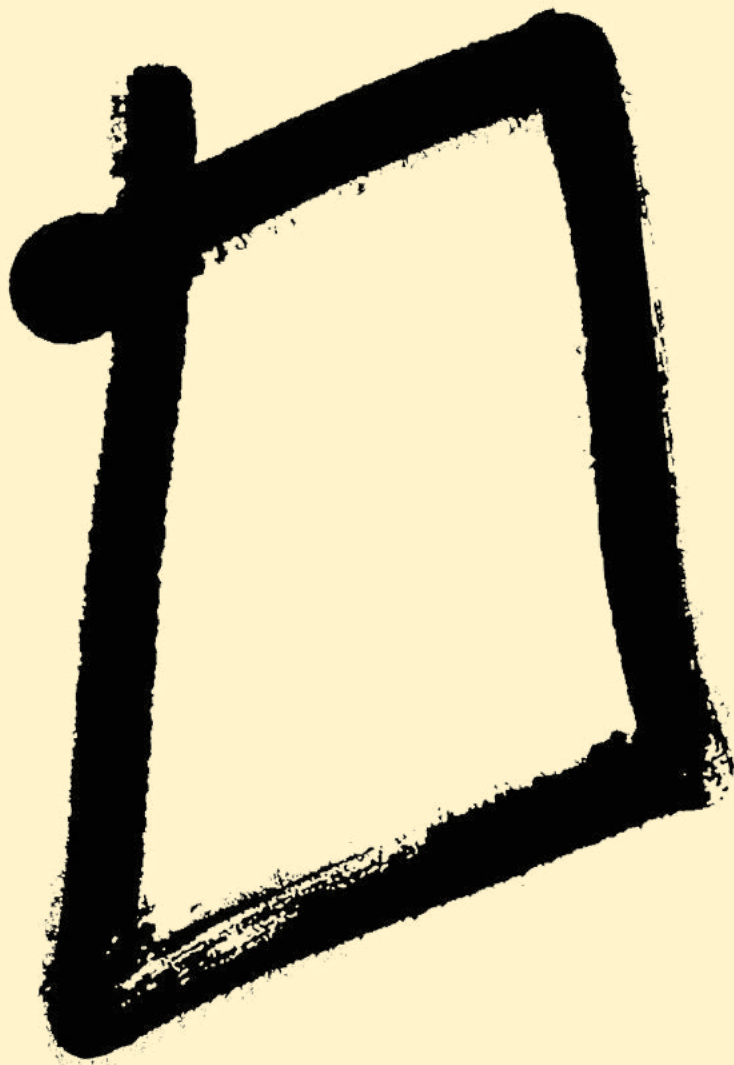

Terrazzo

Escofet

Inspirado en el *Terrazzo* original veneciano del siglo XV, desarrollado para aprovechar los trozos sobrantes de mármol, este modelo conforma un pavimento continuo y sin directrices. De colocación aleatoria, la morfología de su relieve fragmentado se impone al despiece del formato hexagonal. La textura alisada Vibrazolux® deja a la vista el árido en la superficie de las mesetas fracturadas, segunda interpretación a menor escala del pavimento originario.

Inspired by the original Venetian Terrazzo of the 15th century, developed to make use of leftover marble pieces, this model forms a continuous pavement without guidelines. Randomly placed, the morphology of its fragmented relief is imposed on the cut hexagonal format. The smoothed Vibrazolux® texture reveals the aggregate on the surface of the fractured plateaus, a second reinterpretation of the original pavement on a smaller scale.

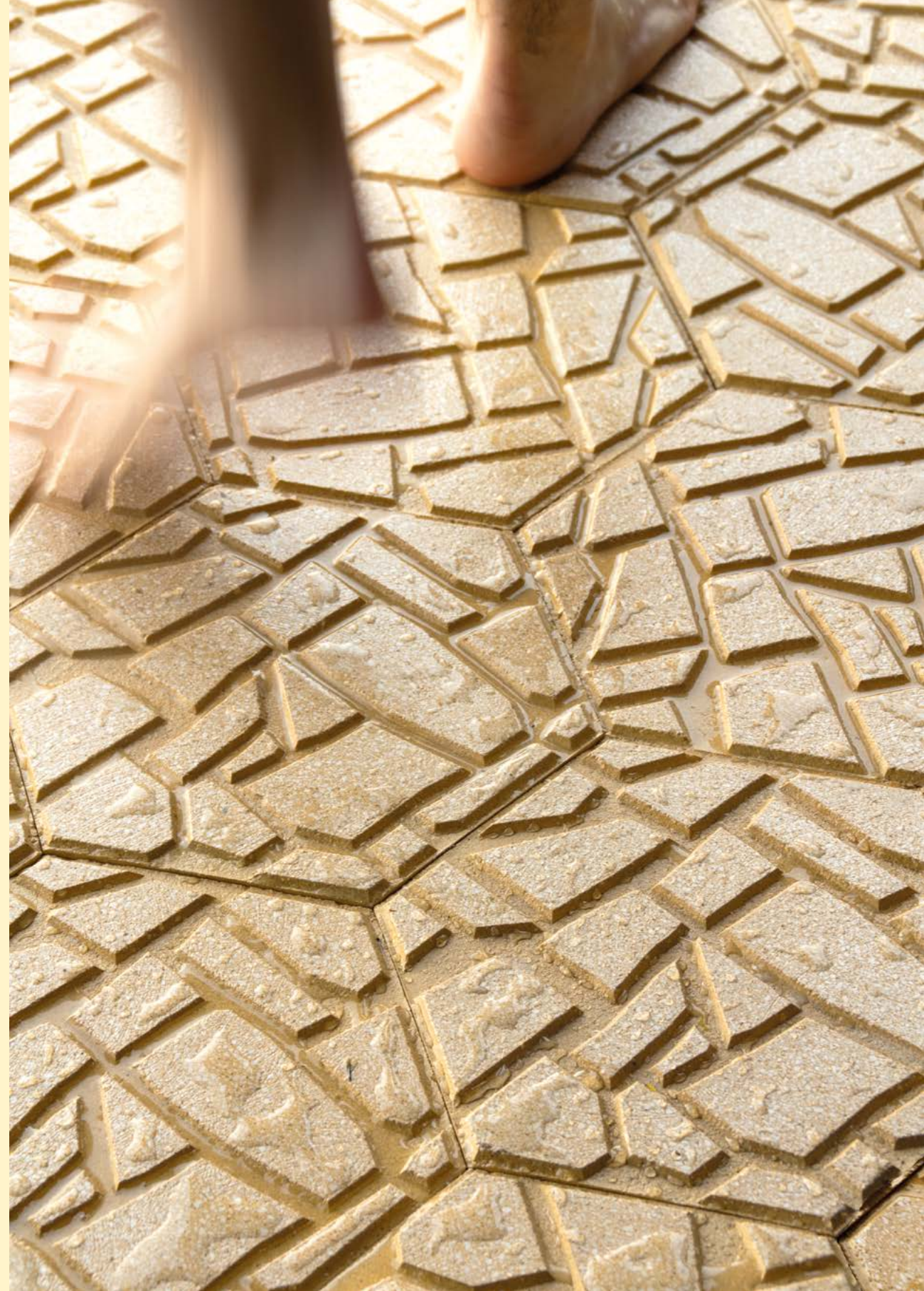



Terrazzo

The skin of the city

Carta de colores / Colour chart

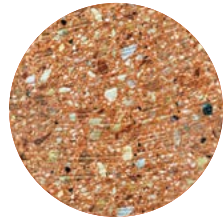

R.JC. Rojo Coral / Coral Red



OC. Ocre / Ocher

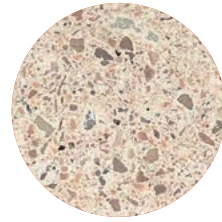

BA. Beige Arena /
Sand Beige

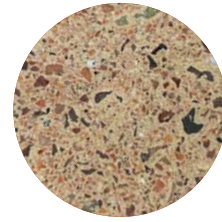

MRH. Marrón Habana /
Havana Brown

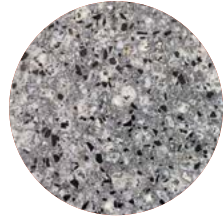

GRM. Gris Ceniza /
Ash Grey

Diseño / Design

28.9

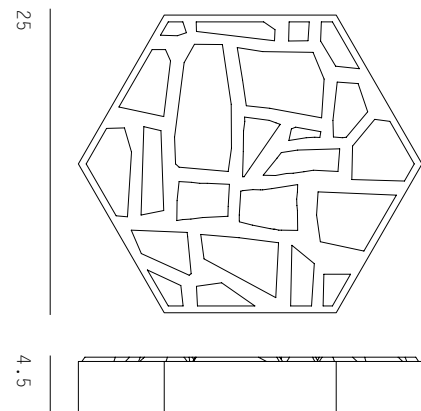

Agregación / Aggregation

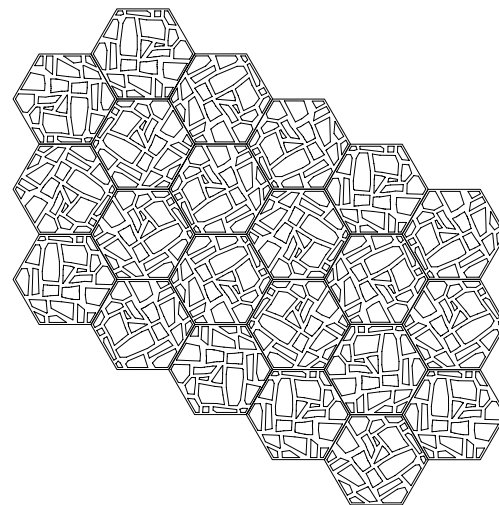

Características / Properties

Información general / General information

Material / Material	Hormigón bicapa vibropresado / Vibro-pressed bilayer concrete
Acabado / Finish	Vibrazolux® textura alisada / Vibrazolux® smooth texture
Colocación / Fixing	Sobre mortero / On mortar (R. min. 100 kg / m ²)
Medidas / Size	28,9 x 25 x 4,5 cm
Peso / Weight	5,56 kg
Unidades m2 / Items m2	18,5 uds. / pc.

Paletización / Palletization

Medidas / Size	80 x 120 x 85 cm
Peso / Weight	1160 kg
Unidades / Items	208 uds. / pc.
Superficie / Surface	11,26 m ²

Otras propiedades / Other properties

UNE-EN 1339/2004

Absorción de agua / Water absorption	Clase 2 / Class 2
Resistencia al hielo-deshielo / Frost resistance	Clase 3 / Class 3
Resistencia al deslizamiento / Slip resistance	Clase 3 / Class 3

Escofet 1886 S.A.
Montserrat 162
E 08760 Martorell
Barcelona - Spain

T. 00 34 93 773 71 50
F. 00 34 93 773 71 66
www.escofet.com

The skin of the city



Exa

Escofet.

La propuesta del pavimento Vibrazolit® pétreo *Exa* se basa en el concepto vinculado al mundo del revestimiento, donde una junta entre azulejos se convierte en una “oportunidad” para crear una nueva ortografía a partir de sus juntas reales o solo dibujadas. Se trata de 3 módulos hexagonales, dos de ellos divididos a su vez en 3 y 2 partes, que brindan la posibilidad de obtener configuraciones aleatorias sin distinción entre ortografía y junta técnica.

The stone-textured Vibrazolit® *Exa* paver proposal is based on a concept linked to the world of cladding, where joints between tiles become an “opportunity” to create a new orthographic projection from their real or drawn joints. It consists of 3 hexagonal modules, two of which are divided into 3 and 2 parts, which provide the possibility to obtain random configurations without distinction between orthographic projection and technical joints.





Exa

The skin of the city

Carta de colores / Colour chart



MR. Marrón Cocoa /
Cocoa Brown

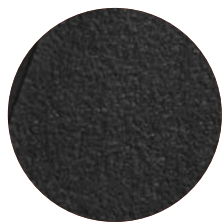

NG. Negro Humo /
Smoke Black

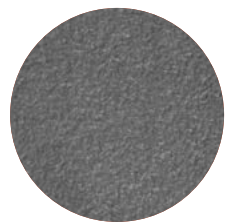

GR. Gris Antracita /
Anthracite Grey



GRC. Gris Perlado /
Pearled Grey

Diseño / Design

Colección / Collection

Exa 25

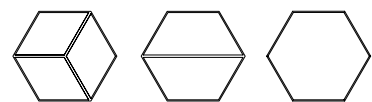

Exa 51

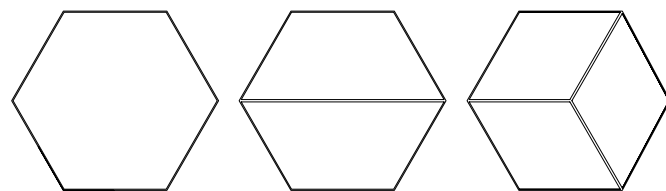

28.9 / 59.4

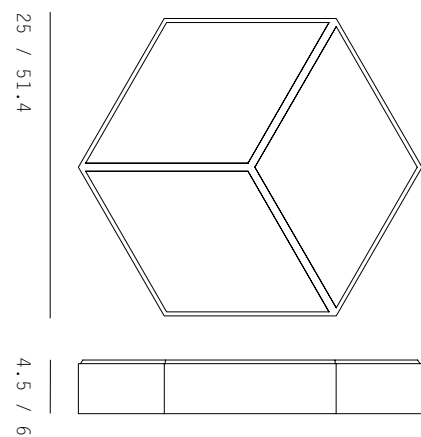

Agregación / Aggregation

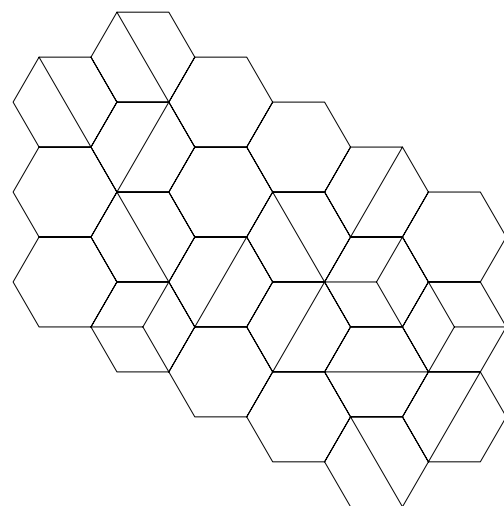

Características / Properties

Información general / General information

Material / Material Hormigón bicapa vibropresado / Vibro-pressed bilayer concrete
Acabado / Finish Vibrazolit® textura pétreo / Vibrazolit® stone-textured
Colocación / Fixing Sobre mortero / On mortar (R. min. 100 kg / m²)

Exa 25

Exa 51

Medidas / Size 28,9 x 25 x 4,5 cm 59,4 x 51,4 x 6 cm
Peso / Weight 5,56 kg 31 kg
Unidades m2 / Items m2 18,5 uds. / pcs. 4,36 uds. / pcs.

Paletización / Palletization

Medidas / Size 80 x 120 x 85 cm 110 x 110 x 96 cm
Peso / Weight 1160 kg 1300 kg
Unidades / Items 208 uds. / pcs. 42 uds. / pcs.
Superficie / Surface 11,26 m² 9,618 m²

Otras propiedades / Other properties

UNE-EN 1339/2004

Absorción de agua / Water absorption Clase 2 / Class 2
Resistencia al hielo-deshielo / Frost resistance Clase 3 / Class 3
Resistencia al deslizamiento / Slip resistance Clase 3 / Class 3

Escofet 1886 S.A.
Montserrat 162
E 08760 Martorell
Barcelona - Spain

T. 00 34 93 773 71 50
F. 00 34 93 773 71 66
www.escofet.com

The skin of the city



Aborígen

Escofet®

Con un dibujo geométrico inspirado en el arte primitivo, las baldosas se extienden formando una malla isótropa de estrellas, puntos y círculos, en la que las juntas desaparecen. La textura alisada Vibrazolux® deja a la vista los áridos integrantes del pavimento *Aborígen*, que afloran en el plano superior, en contraste con el cemento coloreado.

With a geometric drawing inspired by primitive art, the tiles extend forming an isotropic mesh of stars, dots, and circles, in which the joints disappear. With a Vibrazolux® finish, the variable tone of the integral aggregate of the *Aborígen* paver emerges on a higher plane, in contrast with the coloured cement.





Aborígen

The skin of the city

Carta de colores / Colour chart

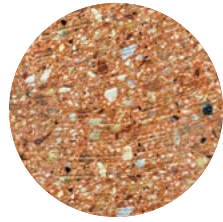

R.JC. Rojo Coral / Coral Red



OC. Ocre / Ocher

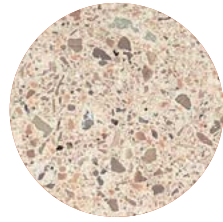

BA. Beige Arena / Sand Beige

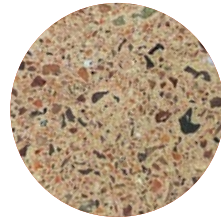

MRH. Marrón Habana / Havana Brown

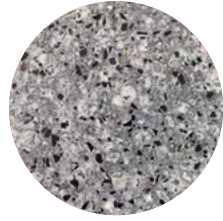

GRM. Gris Ceniza / Ash Grey

Diseño / Design

28.9

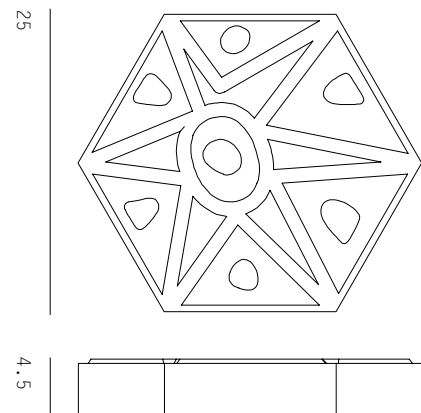

Agregación / Aggregation

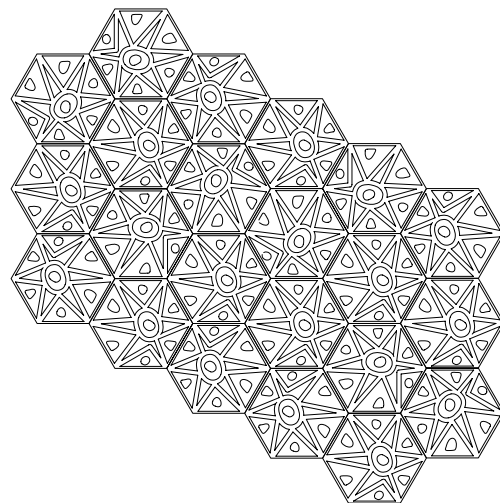

Características / Properties

Información general / General information

Material / Material	Hormigón bicapa vibropresado / Vibro-pressed bilayer concrete
Acabado / Finish	Vibrazolux® textura alisada / Vibrazolux® smooth texture
Colocación / Fixing	Sobre mortero / On mortar (R. min. 100 kg / m ²)
Medidas / Size	28,9 x 25 x 4,5 cm
Peso / Weight	5,56 kg
Unidades m2 / Items m2	18,5 uds. / pc.

Paletización / Palletization

Medidas / Size	80 x 120 x 85 cm
Peso / Weight	1160 kg
Unidades / Items	208 uds. / pc.
Superficie / Surface	11,26 m ²

Otras propiedades / Other properties

UNE-EN 1339/2004

Absorción de agua / Water absorption	Clase 2 / Class 2
Resistencia al hielo-deshielo / Frost resistance	Clase 3 / Class 3
Resistencia al deslizamiento / Slip resistance	Clase 3 / Class 3

Escofet 1886 S.A.
Montserrat 162
E 08760 Martorell
Barcelona - Spain

T. 00 34 93 773 71 50
F. 00 34 93 773 71 66
www.escofet.com

The skin of the city



Moderna

Escofet

La baldosa *Moderna* en Vibrazolit® relieve reproduce tres motivos florales anclados en los vértices del hexágono. Su instalación permite componer patrones homogéneos o aleatorios según la disposición de las baldosas en la superficie.

The *Moderna* Vibrazolit® relief tile reproduces three floral motifs anchored in the vertices of the hexagon. Its placement enables composition of homogeneous or random patterns according to the layout of the tiles on the surface.





Moderna

The skin of the city

Carta de colores / Colour chart

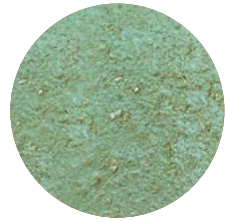

VD. Verde Jade /
Jade Green



RJ. Rojo Persa /
Persian Red



AM. Amarillo Ceilán /
Ceylan Yellow

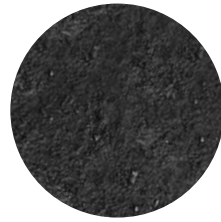

NG. Negro Humo /
Smoke Black

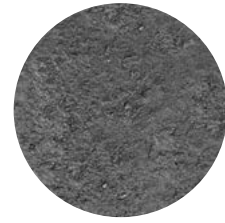

GR. Gris Antracita /
Anthracite Grey

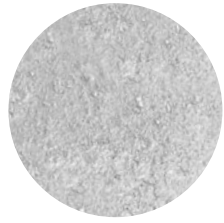

GRC. Gris Perlado /
Pearled Grey

Diseño / Design

28.9

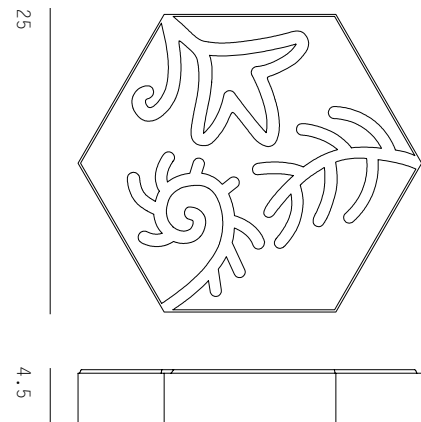

Agregación / Aggregation

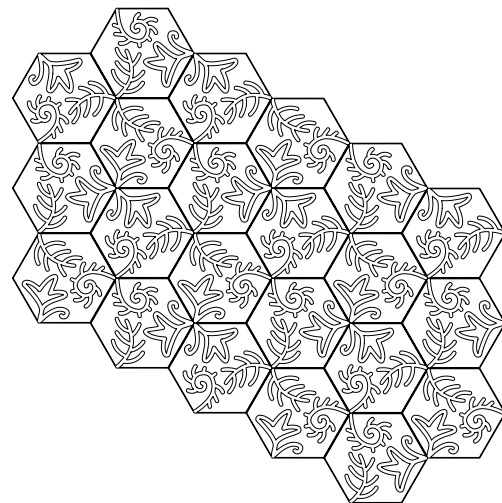

Características / Properties

Información general / General information

Material / Material	Hormigón bicapa vibropresado / Vibro-pressed bilayer concrete
Acabado / Finish	Vibrazolit® textura relieve / Vibrazolit® relief texture
Colocación / Fixing	Sobre mortero / On mortar (R. min. 100 kg / m ²)
Medidas / Size	28,9 x 25 x 4,5 cm
Peso / Weight	5,56 kg
Unidades m2 / Items m2	18,5 uds. / pc.

Paletización / Palletization

Medidas / Size	80 x 120 x 85 cm
Peso / Weight	1160 kg
Unidades / Items	208 uds. / pc.
Superficie / Surface	11,26 m ²

Otras propiedades / Other properties

UNE-EN 1339/2004

Absorción de agua / Water absorption	Clase 2 / Class 2
Resistencia al hielo-deshielo / Frost resistance	Clase 3 / Class 3
Resistencia al deslizamiento / Slip resistance	Clase 3 / Class 3

Escofet 1886 S.A.
Montserrat 162
E 08760 Martorell
Barcelona - Spain

T. 00 34 93 773 71 50
F. 00 34 93 773 71 66
www.escofet.com

The skin of the city



Parallel

Escofet®

El diseño del pavimento *Parallel* reproduce una caligrafía continua de seis sencillos arabescos paralelos, enlazados en continuidad y de forma lineal entre baldosas. El acabado Vibrazolit® relieve le aporta sutiles contrastes de luz y sombra, variable en función del ángulo de la luz incidente.

The *Parallel* paver design reproduces a continuous calligraphy of six simple parallel arabesques, continuously and linearly linked between tiles. The Vibrazolit® relief finish provides subtle contrasts of light and shade, variable depending on the angle of incident light.

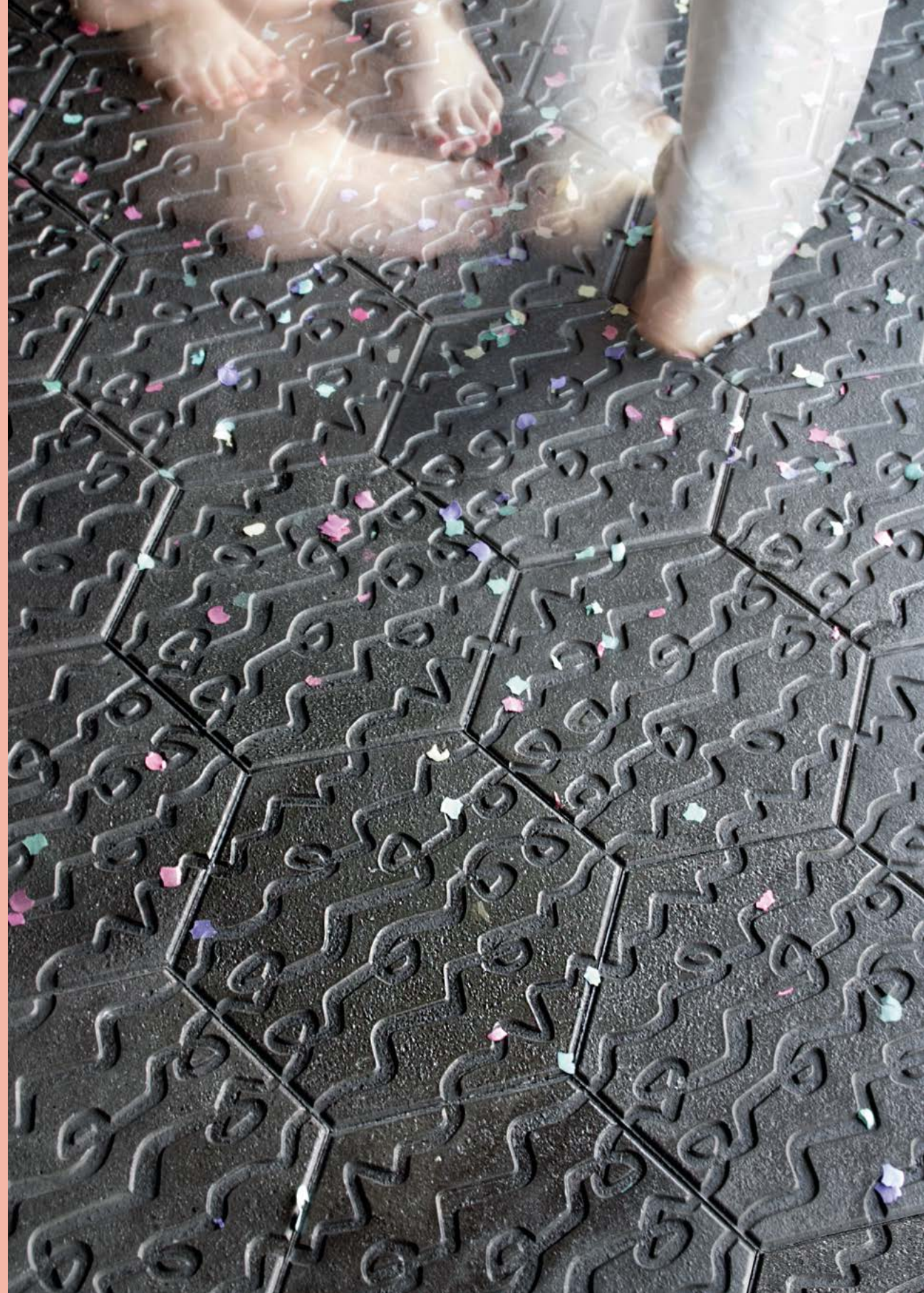



Parallel

The skin of the city

Carta de colores / Colour chart

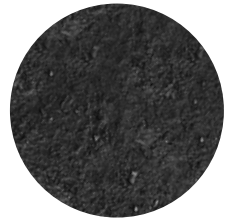

NG. Negro Humo /
Smoke Black

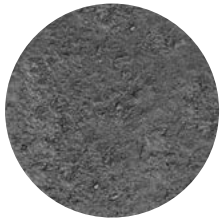

GR. Gris Antracita /
Anthracite Grey

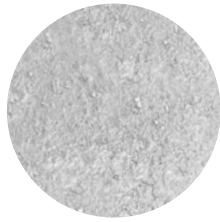

GRC. Gris Perlado /
Pearled Grey

Diseño / Design

28.9

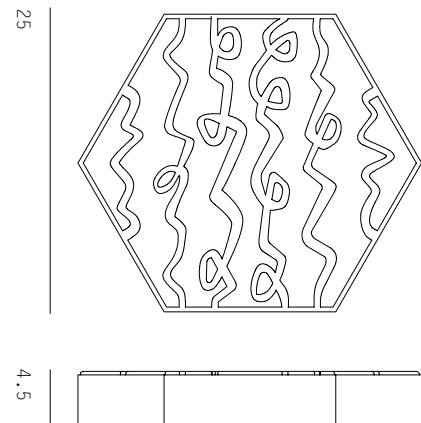

Agregación / Aggregation

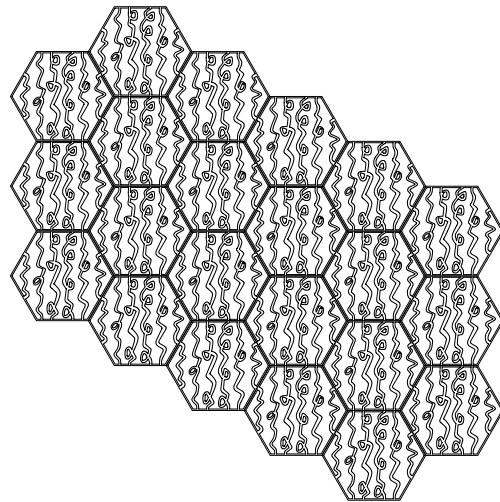

Características / Properties

Información general / General information

Material / Material	Hormigón bicapa vibropresado / Vibro-pressed bilayer concrete
Acabado / Finish	Vibrazolit® textura relieve / Vibrazolit® relief texture
Colocación / Fixing	Sobre mortero / On mortar (R. min. 100 kg / m ²)
Medidas / Size	28,9 x 25 x 4,5 cm
Peso / Weight	5,56 kg
Unidades m2 / Items m2	18,5 uds. / pc.

Paletización / Palletization

Medidas / Size	80 x 120 x 85 cm
Peso / Weight	1160 kg
Unidades / Items	208 uds. / pc.
Superficie / Surface	11,26 m ²

Otras propiedades / Other properties

UNE-EN 1339/2004

Absorción de agua / Water absorption	Clase 2 / Class 2
Resistencia al hielo-deshielo / Frost resistance	Clase 3 / Class 3
Resistencia al deslizamiento / Slip resistance	Clase 3 / Class 3

Escofet 1886 S.A.
Montserrat 162
E 08760 Martorell
Barcelona - Spain

T. 00 34 93 773 71 50
F. 00 34 93 773 71 66
www.escofet.com

The skin of the city



Poblenou

Escofet®

El diseño *Poblenou* propone un modelo combinable en Vibrazolit® pétreo en el que las juntas y la gráfica en bajo-relieve se funden en una superficie de malla isótropa. Utilizando como método la “factura imperfecta del dibujo” el autor plantea un hexágono central deformado que, unido con surcos de desagüe al perímetro exterior, genera una pieza de colocación aleatoria.

The *Poblenou* design proposes a combinable model in stone Vibrazolit® in which the low-relief joints and graphics are fused in an isotropic mesh surface. Using the “imperfect workmanship of drawing” as a method, the designer proposes an offset central hexagon that, together with grooves for drainage to the outer perimeter, generates a randomly placed piece.





Poblenou

The skin of the city

Carta de colores / Colour chart



R.J. Rojo Persa /
Persian Red



AM. Amarillo Ceilán /
Ceylan Yellow

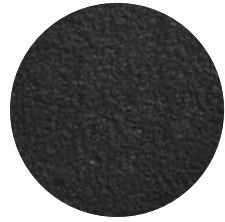

NG. Negro Humo /
Smoke Black

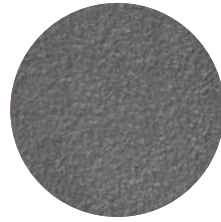

GR. Gris Antracita /
Anthracite Grey



GRC. Gris Perlado /
Pearled Grey

Diseño / Design

28.9

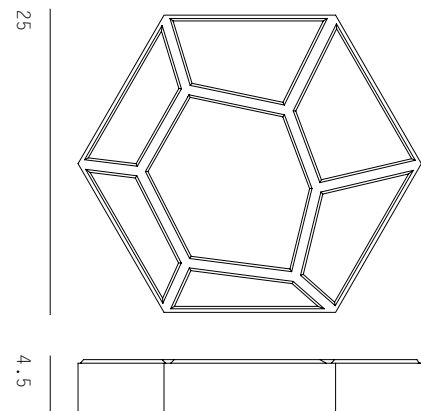

Agregación / Aggregation

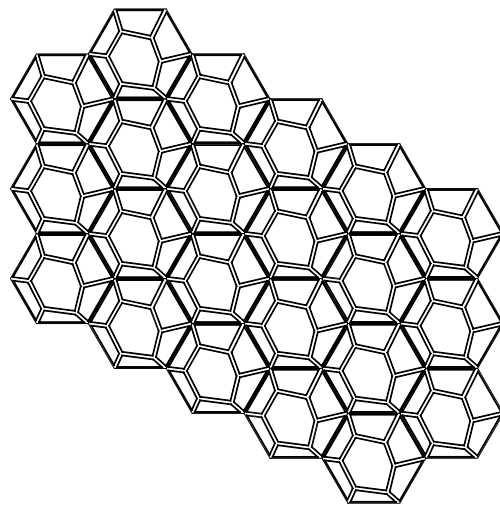

Características / Properties

Información general / General information

Material / Material	Hormigón bicapa vibropresado / Vibro-pressed bilayer concrete
Acabado / Finish	Vibrazolit® textura pétreo / Vibrazolit® stone-textured
Colocación / Fixing	Sobre mortero / On mortar (R. min. 100 kg / m ²)
Medidas / Size	28,9 x 25 x 4,5 cm
Peso / Weight	5,56 kg
Unidades m2 / Items m2	18,5 uds. / pc.

Paletización / Palletization

Medidas / Size	80 x 120 x 85 cm
Peso / Weight	1160 kg
Unidades / Items	208 uds. / pc.
Superficie / Surface	11,26 m ²

Otras propiedades / Other properties

UNE-EN 1339/2004

Absorción de agua / Water absorption	Clase 2 / Class 2
Resistencia al hielo-deshielo / Frost resistance	Clase 3 / Class 3
Resistencia al deslizamiento / Slip resistance	Clase 3 / Class 3

Escofet 1886 S.A.
Montserrat 162
E 08760 Martorell
Barcelona - Spain

T. 00 34 93 773 71 50
F. 00 34 93 773 71 66
www.escofet.com

The skin of the city



Gaudí

Escofet®

El panot *Gaudí* es un pavimento Vibrazolit® con textura relieve, adaptación de la baldosa hidráulica que Antoni Gaudí diseñó en 1904 para la casa Batlló y finalmente instalada en La Pedrera en 1906. En este modelo los motivos marinos se presentan con el relieve invertido respecto al original para asegurar su durabilidad frente la erosión del uso peatonal.

The *Gaudí* panot is a Vibrazolit® paver with relief texture; an adaptation of the hydraulic tile that Antoni Gaudí designed in 1904 for Casa Batlló and finally installed in La Pedrera in 1906. In this model, the maritime motifs are presented in inverted relief with respect to the original to ensure durability against the erosion of pedestrian use.

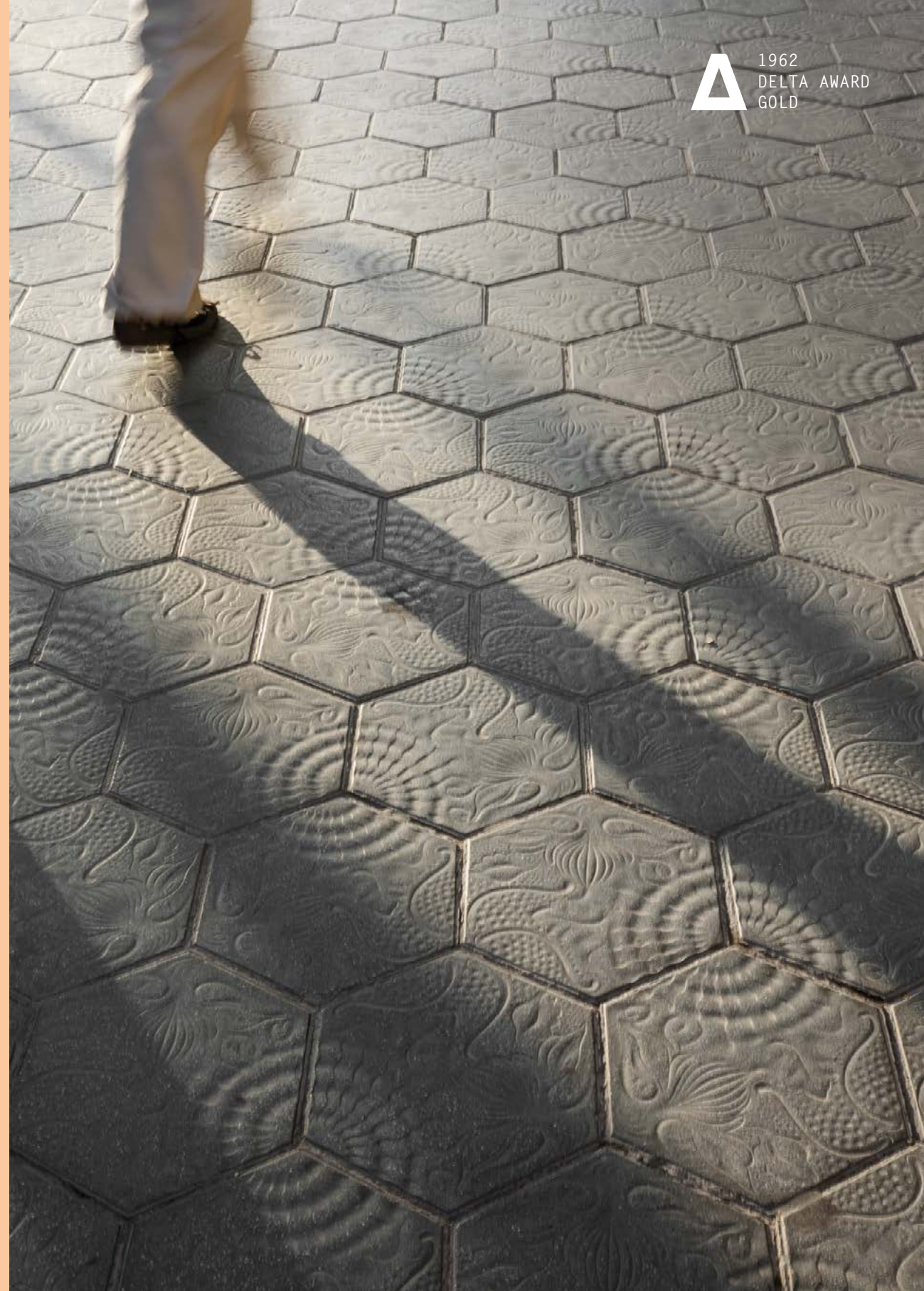



Gaudí

The skin of the city

Carta de colores / Colour chart



GV. Verde Musgo /
Moss Green



RJ. Rojo Persa /
Persian Red



AM. Amarillo Ceilán /
Ceylan Yellow

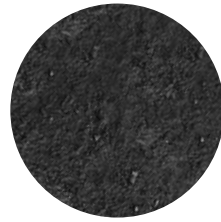

NG. Negro Humo /
Smoke Black

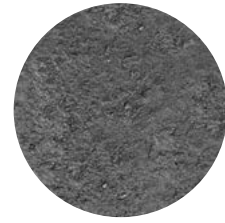

GR. Gris Antracita /
Anthracite Grey

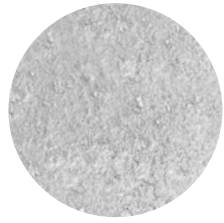

GRC. Gris Perlado /
Pearled Grey



BL. Blanco Cuarzo /
Quartz White

Diseño / Design

28.9

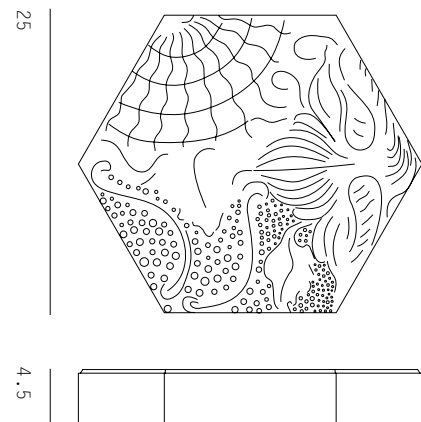

Agregación / Aggregation

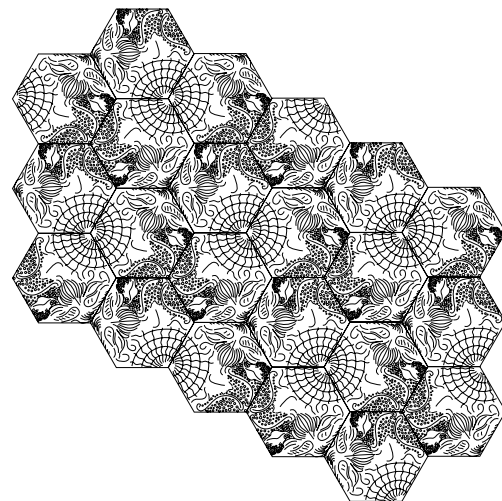

Antoni Gaudí, 1904

Características / Properties

Información general / General information

Material / Material	Hormigón bicapa vibropresado / Vibro-pressed bilayer concrete
Acabado / Finish	Vibrazolit® textura relieve / Vibrazolit® relief texture
Colocación / Fixing	Sobre mortero / On mortar (R. min. 100 kg / m ²)
Medidas / Size	28,9 x 25 x 4,5 cm
Peso / Weight	5,56 kg
Unidades m2 / Items m2	18,5 uds. / pc.

Paletización / Palletization

Medidas / Size	80 x 120 x 85 cm
Peso / Weight	1160 kg
Unidades / Items	208 uds. / pc.
Superficie / Surface	11,26 m ²

Otras propiedades / Other properties

UNE-EN 1339/2004

Absorción de agua / Water absorption	Clase 2 / Class 2
Resistencia al hielo-deshielo / Frost resistance	Clase 3 / Class 3
Resistencia al deslizamiento / Slip resistance	Clase 3 / Class 3

Gaudí

The skin of the city

Escofet 1886 S.A.
Montserrat 162
E 08760 Martorell
Barcelona - Spain

T. 00 34 93 773 71 50
F. 00 34 93 773 71 66
www.escofet.com

The skin of the city



Trébol

Escofet®

Trébol interpreta la naturaleza con elevada intencionalidad poética en teselado hexagonal, resultando un pavimento Vibrazolit® relieve de inspiración botánica y extraordinaria versatilidad de uso. El bajo relieve en forma de nervadura, que cubre enteramente la superficie de las hojas, así como la comba adquirida de la parte del limbo para evacuar el agua, le aportan excelentes condiciones antideslizantes, así como una confortable pisada.

Trébol interpretes nature with a highly poetic intentionality through an hexagonal tessellation. The result is a Vibrazolit® relief paver of botanical inspiration and extraordinary versatility of use. The low relief in the form of a rib, which entirely covers the surface of the leaves, as well as the camber acquired from the part of the limbus for water drainage, provide excellent anti-slip conditions, as well as a comfortable footstep.



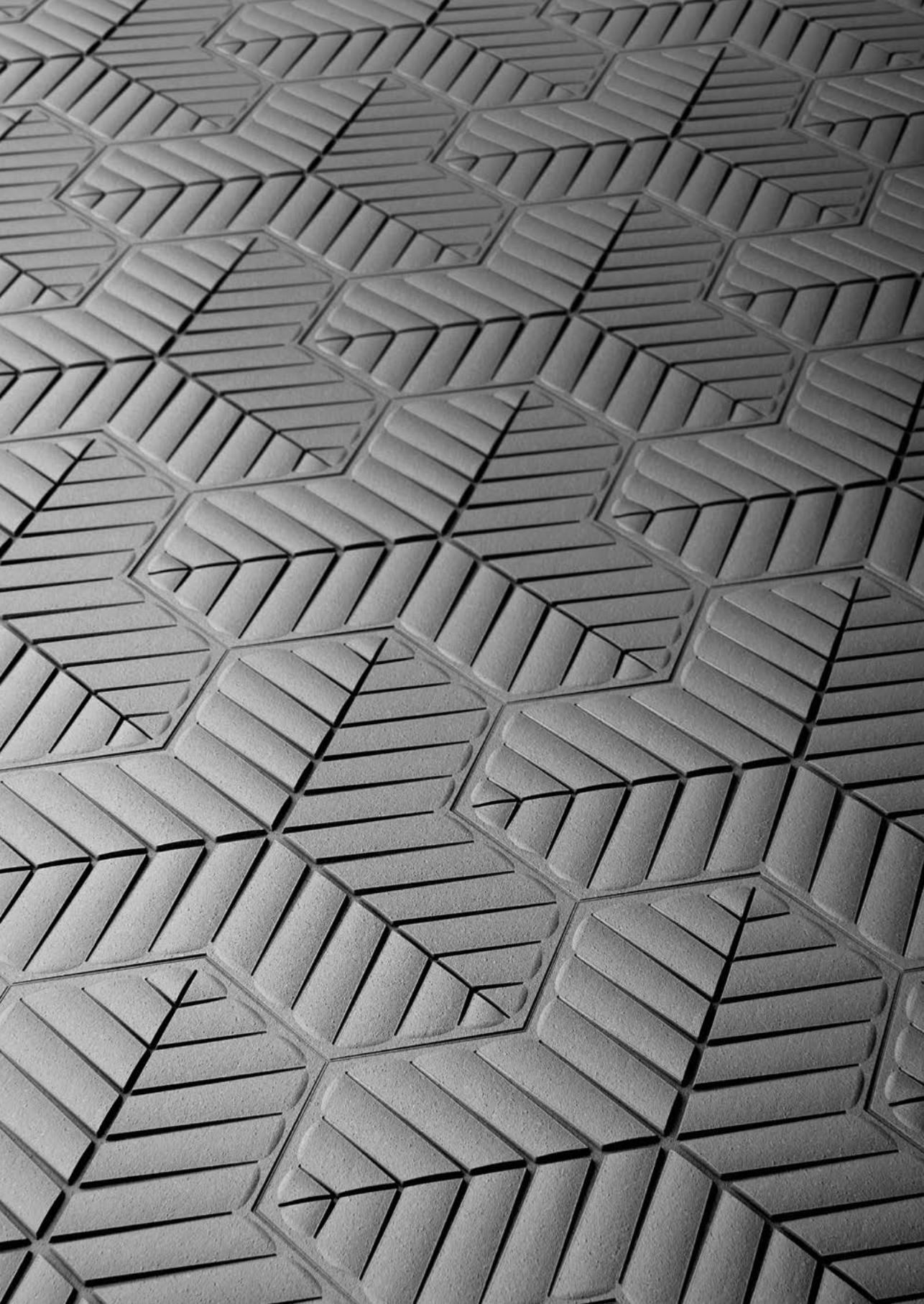

Trébol

The skin of the city

Carta de colores / Colour chart



GV. Verde Musgo /
Moss Green



CM. Camel / Camel

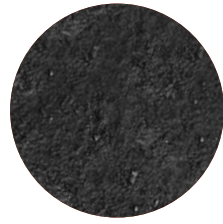

NG. Negro Humo /
Smoke Black

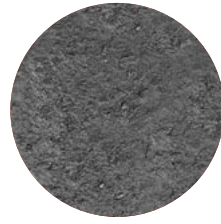

GR. Gris Antracita /
Anthracite Grey

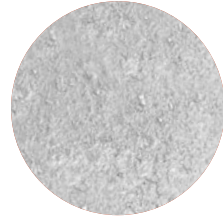

GRC. Gris Perlado /
Pearled Grey

Diseño / Design

30

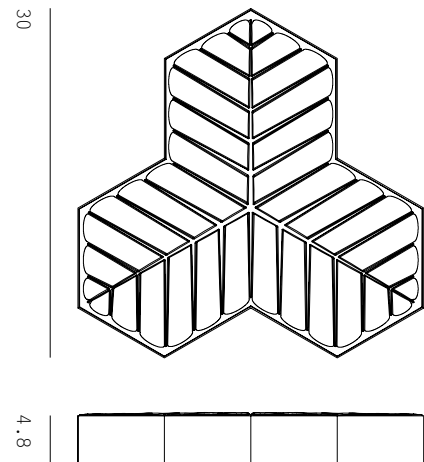

Agregación / Aggregation

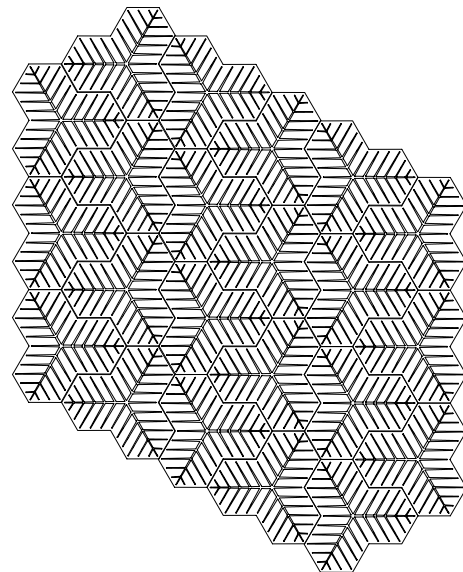

Características / Properties

Información general / General information

Material / Material	Hormigón bicapa vibropresado / Vibro-pressed concrete
Acabado / Finish	Vibrazolit® textura relieve / Vibrazolit® relief texture
Colocación / Fixing	Sobre mortero / On mortar (R. min. 100 kg / m ²)
Medidas / Size	30 x 30 x 4,8 cm
Peso / Weight	6,5 kg
Unidades m2 / Items m2	17 uds. / pc.

Paletización / Palletization

Medidas / Size	80 x 120 x 85 cm
Peso / Weight	1350 kg
Unidades / Items	208 uds. / pc.
Superficie / Surface	11,26 m ²

Otras propiedades / Other properties

UNE-EN 1339/2004

Absorción de agua / Water absorption	Clase 2 / Class 2
Resistencia al hielo-deshielo / Frost resistance	Clase 3 / Class 3
Resistencia al deslizamiento / Slip resistance	Clase 3 / Class 3

Escofet 1886 S.A.
Montserrat 162
E 08760 Martorell
Barcelona - Spain

T. 00 34 93 773 71 50
F. 00 34 93 773 71 66
www.escofet.com

The skin of the city



Diagonal

Escofet®

El pavimento Vibrazolit® relieve *Diagonal* tiene su origen en la reforma de la avenida Diagonal de Barcelona. El dibujo del pavimento, formado por la yuxtaposición de cuatro piezas, reproduce el contorno y la textura de la hoja del *Platanus hispanica*. Estos árboles de gran porte configuran un umbráculo, imagen más representativa de la avenida.

The *Diagonal* Vibrazolit® relief paver has its origin in the reform of Avenida Diagonal in Barcelona. The paver pattern, formed by the juxtaposition of four pieces, reproduces the contour and texture of the *Platanus hispanica* leaf. These large trees form a shading structure, the most representative image of the avenue.





Diagonal

The skin of the city

Carta de colores / Colour chart



GV. Verde Musgo /
Moss Green

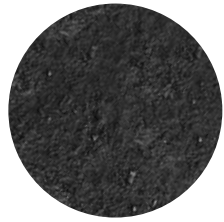

NG. Negro Humo /
Smoke Black

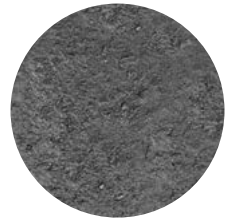

GR. Gris Antracita /
Anthracite Grey

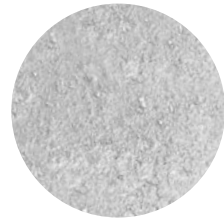

GRC. Gris Perlado /
Pearled Grey

Diseño / Design

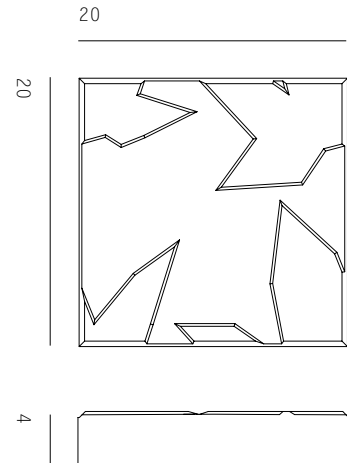

Agregación / Aggregation

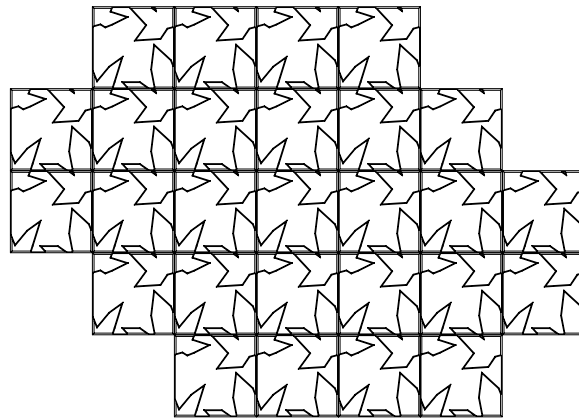

Características / Properties

Información general / General information

Material / Material	Hormigón bicapa vibropresado / Vibro-pressed bilayer concrete
Acabado / Finish	Vibrazolit® textura relieve / Vibrazolit® relief texture
Colocación / Fixing	Sobre mortero / On mortar (R. min. 100 kg / m ²)
Medidas / Size	20 x 20 x 4 cm
Peso / Weight	3,5 kg
Unidades m2 / Items m2	24 uds. / pc.

Paletización / Palletization

Medidas / Size	80 x 120 x 85 cm
Peso / Weight	1512 kg
Unidades / Items	432 uds. / pc.
Superficie / Surface	17,28 m ²

Otras propiedades / Other properties

UNE-EN 1339/2004

Absorción de agua / Water absorption	Clase 2 / Class 2
Resistencia al hielo-deshielo / Frost resistance	Clase 3 / Class 3
Resistencia al deslizamiento / Slip resistance	Clase 3 / Class 3

Escofet 1886 S.A.
Montserrat 162
E 08760 Martorell
Barcelona - Spain

T. 00 34 93 773 71 50
F. 00 34 93 773 71 66
www.escofet.com

The skin of the city

Info

Escofet®

Escofet presenta una renovada oferta de pavimento vibropresado con la voluntad de dar respuesta a un mercado diferenciado de baldosas de autor. Proyectos emblemáticos y de largo recorrido avalan esta tecnología en infinidad de emplazamientos.

Escofet presents a renewed range of vibro pressed concrete pavers with the aim of responding to the needs of a differentiated creative floor tile market. This technology is endorsed by a series of emblematic and long-established designs in an infinite number of sites.



Ventajas / Benefits

Proceso de producción fiable y sostenible /
Reliable & sustainable production process

Versatilidad de formatos /
Versatile formats

Relieves y texturas personalizadas /
Personalised reliefs & textures

Alta fidelidad en la reproducción
de motivos / High fidelity reproduction
of motifs

Óptimo comportamiento mecánico /
Optimum mechanical behaviour

Sistema de colocación eficiente /
Efficient laying system

Garantía de perdurabilidad /
Guaranteed to last

Materializando una idea

La versatilidad de la tecnología del vibroprensado cara abajo permite diseñar y producir baldosas de forma y textura compleja, con diferentes relieves personalizados.

La variedad de los áridos y la utilización de los pigmentos, combinándolos con cemento blanco o cemento gris, nos abre de forma creativa toda una gama de colores vivos o atenuados. En los formatos hexagonal de 25 y 51 cm y formato cuadrado de 20 cm es posible fabricar una amplia oferta de modelos personalizados, con una moderada inversión en moldes.



Fabricación e instalación / Production & installation

Materializing an idea

The versatility of the face-down vibropressed technology enables design and production of tiles with complex shapes and textures, with different customized reliefs.

The variety of aggregates and use of pigments, combined with white or grey cement, open a creative path to an entire range of bright or attenuated colours. In the 25 and 51 cm hexagonal formats and 20 cm square formats, it is possible to manufacture a wide range of customized models, with a moderate investment in moulds.

Colores y acabados

La colección de los pavimentos de composición bicapa de *Escofet* se fabrican con dos acabados: *Vibrazolit®* para baldosas con texturas relieve y pétreo, y el acabado *Vibrazolux®* que requiere un proceso post-producción de rebajado y alisado dejando los áridos a la vista.

El relieve y textura se consiguen con un fondo de molde de elastómero que los reproduce, mientras que el color y tonalidad se consigue por combinación de áridos, colorantes inorgánicos, aditivos y cemento blanco o gris de alta resistencia.

Colours and finishes

Escofet's double-layer paver line is manufactured with two finishes: *Vibrazolit®* for with relief and stone textured tiles, and *Vibrazolux®* finishing that requires a post-production process for deburring and polishing, revealing the aggregate on the surface.

Relief and texture are achieved with an elastomer mould bottom, while colour and tonality are achieved by the combination of aggregates, inorganic colourants, additives, and high strength white or grey cement.



Info

The skin of the city

Colocación sobre mortero

Las baldosas se asientan sobre una losa rígida de hormigón de 15 a 18 cm, para uso peatonal con tráfico ocasional de vehículos de servicio, vertida sobre una sub-base explanada de tierra.

En su colocación las baldosas se extienden sobre un lecho de mortero de consistencia semiblanda con un espesor de mínimo de 3 cm. y máximo de 5 cm, y un vertido intermedio de lechada cementosa sobre el mortero para mejorar la adherencia. Para un uso intensivo o industrial la resistencia característica del mortero será de 100-140 Kg/cm².



Installation on mortar

The tiles sit on a rigid concrete slab of 15 to 18 cm, designed for pedestrian use with occasional vehicle traffic service, poured on a soil sub-base.

For installation, the tiles are spread over a semi-soft mortar bed with a minimum thickness of 3 cm and maximum of 5 cm, and an intermediate pour of cement slurry on the mortar to improve adhesion. For intensive or industrial use, the characteristic resistance of the mortar shall be 100-140 Kg/cm².

Dirección edición / Editing manager
Enric Pericas, Andreu Gomá

Coordinación / Coordination
Gerard Arqué

Concepto y diseño / Concept and design
Meritxell Casamira

Asistencia técnica / Technical assistance
José Florido

Textos / Texts
Escofet

Fotografías / Photographs
Escofet
Anna Pericas

Ilustraciones / Illustrations
Escofet

Traducción / Translation
Rayma Traducciones, S.L.

Impresión / Printing
CG Creaciones Gráficas, S.A.

Primera edición / First edition
Junio 2019 / June 2019

Copyright © Escofet 2019

Escofet inició su larga trayectoria en la edición pavimentos alimentando el vínculo entre el mundo creativo y la industria del pavimento, y apostando por la excelencia y la calidad de los profesionales que la han acompañado. A todos ellos dedicamos esta edición en agradecimiento a su colaboración.

Escofet began its long career in the design of pavements by sustaining the link between the creative world and the pavement industry, with a commitment to excellence and quality of the professionals involved. We dedicate this edition to all of them in appreciation of their collaboration.

Escofet 1886 S.A.
Montserrat 162
E 08760 Martorell
Barcelona - Spain

T. 00 34 93 773 71 50
F. 00 34 93 773 71 66
www.escofet.com