

Las ciudades no duermen. Cuando el sol se pone y la luz desaparece, *Lighting* nos facilita la oportunidad de disfrutar de la otra cara de la ciudad: la noche. Las farolas, columnas y balizas, iluminan y señalizan el espacio público en su uso nocturno.

Cities do not sleep. When the sun sets and the light fades, *Lighting* helps us to enjoy the other face of the city: its nightlife. Street lamps, columns and pathway lights illuminate and mark public spaces for their night time use.

Escofet®

Dirección edición / Editing manager

Enric Pericas, Andreu Gomà

Coordinación edición / Editing coordination

Francisco Granados, Xavier Ruiz

Concepto y diseño / Concept and design

Meritxell Casamira

Textos / Texts

Escofet

Fotografías / Photography

Adrià Goula

Anna Pericas

Gael del Río

Nicanor García

Wenzel Fotografía

Escofet

Traducción / Translation

Siens Translation

Impresión / Printing

CG Creaciones Gráficas, S.A.

Primera edición / First edition

Marzo 2020 / March 2020

Copyright © Escofet 2020

Prólogo / Prologue

Escofet 1886 S.A

Oficina central y producción/
Head office and production

Montserrat, 162

E 08760 Martorell

Barcelona - España

T. 0034 937 737 150

F. 0034 937 737 151

info@escofet.com

www.escofet.com

Escofet ha nacido y se ha desarrollado en estrecha vinculación con Barcelona, escaparate de su obra y creatividad. Desde nuestra ciudad, proyectamos internacionalmente el carácter mediterráneo de *Escofet*, iluminando avenidas, parques, calles, plazas y bulevares de todo el mundo.

Escofet has maintained its place of origin and the showcase of its work and creativity in the city of Barcelona. From our home city, we internationally project *Escofet's* Mediterranean character, lighting avenues, parks, streets, squares and boulevards around the world.



El diseño de iluminación se ha ido transformado en una parte intrínseca y esencial del paisaje urbano. Este catálogo refleja esta progresión, reconociendo a los arquitectos y diseñadores que han asumido el reto de desarrollar nuevas propuestas de alumbrado.

The discipline of lighting design has now become an intrinsic and essential part of the urban landscape. This catalogue reflects this progression, recognizing architects and designers who have taken up the challenge of developing new lighting proposals.



Miramos el pasado avanzando hacia el futuro, para encontrar el punto de equilibrio entre tradición e innovación. Su resultado es un profundo conocimiento de una disciplina tan importante como es el diseño de la iluminación del paisaje urbano.

We look to the past moving towards the future to find that insight, unearthing both old wisdom and fresh thinking. Bringing a new depth of understanding to this most important aspect of urban landscape lighting design.



Luminarias urbanas / Urban lamps

WIDE

012

BALI

024

ORBIT

036

Luminarias de paisaje / Landscape lamps

FUL

044

KANYA

056

CREAM

068

PRISMA

078

INTER

088

LOLA

098

Balizas / Beacons

MOTA

108

QUAKE

112

MORELLA

116

WIDE

Los objetivos que impulsan la concepción de *Wide* son disponer de una luminaria contemporánea, tecnológica, formalmente diferenciada de un producto estándar y principalmente una clara lectura de su morfología: Un bastidor que acoge la luminaria, disponible en dos longitudes adaptadas, a las distintas potencias instaladas en tecnología LED.

The objective behind the *Wide* concept is to create a contemporary lamp that is technologically and formally different from standard products, and principally, that of a clear interpretation of its morphology: A frame that holds the lamp with two lengths adapted to different installed LED technology powers.

IP66 | IK08 | ⚡ | 10 KV¹ | CE | UNE-EN 40-50

Propiedades / Properties

¹Opcional / Optional

012

Wide

Ton Riera, 2017



liba
LANDSCAPE INTERNATIONAL
LANDSCAPE AWARD

2018
LANDEZINE INTERNATIONAL
LANDSCAPE AWARD



Carrer Pere IV, Barcelona, Spain

Wide

El gran abanico de configuraciones y ópticas de *Wide* permiten una precisa distribución lumínica por la noche y una discreta presencia durante el día.

The wide range of height, configurations and optics of *Wide* give rise to a precise light distribution at night and a discreet presence during the day.

Luminaria / Luminaire

Potencias / Powers (W)

25 / 50 / 75 / 100

Temperatura color / Color temperature (°K)

3000 Blanco cálido / Warm white

4000 Blanco neutro / Neutral white

Flujo luminoso / Luminous flux (lm)

● 2822 - 10773 Blanco cálido / Warm white

○ 2994 - 11673 Blanco neutro / Neutral white

Eficacia luminaria / Luminous efficiency (lm/W)

95 - 100 Blanco cálido / Warm white

101 - 110 Blanco neutro / Neutral white

Materiales / Materials

● Aluminio anodizado / Anodized aluminium

Columna / Column

Pesos / Weights

100 kg (4 m); 118 kg (5 m); 136 kg (6 m); 154 kg (7 m);

172 kg (8 m); 190 kg (9 m)

Diámetro / Diameter

140 mm

Espesor / Thickness

5 mm

Refuerzo / Reinforcement

4 mm anillo inferior / Bottom ring

Materiales / Materials

● RAL 9006 Acero galvanizado / Galvanized steel

● Acero galvanizado / Galvanized steel

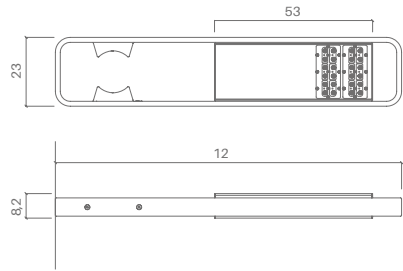
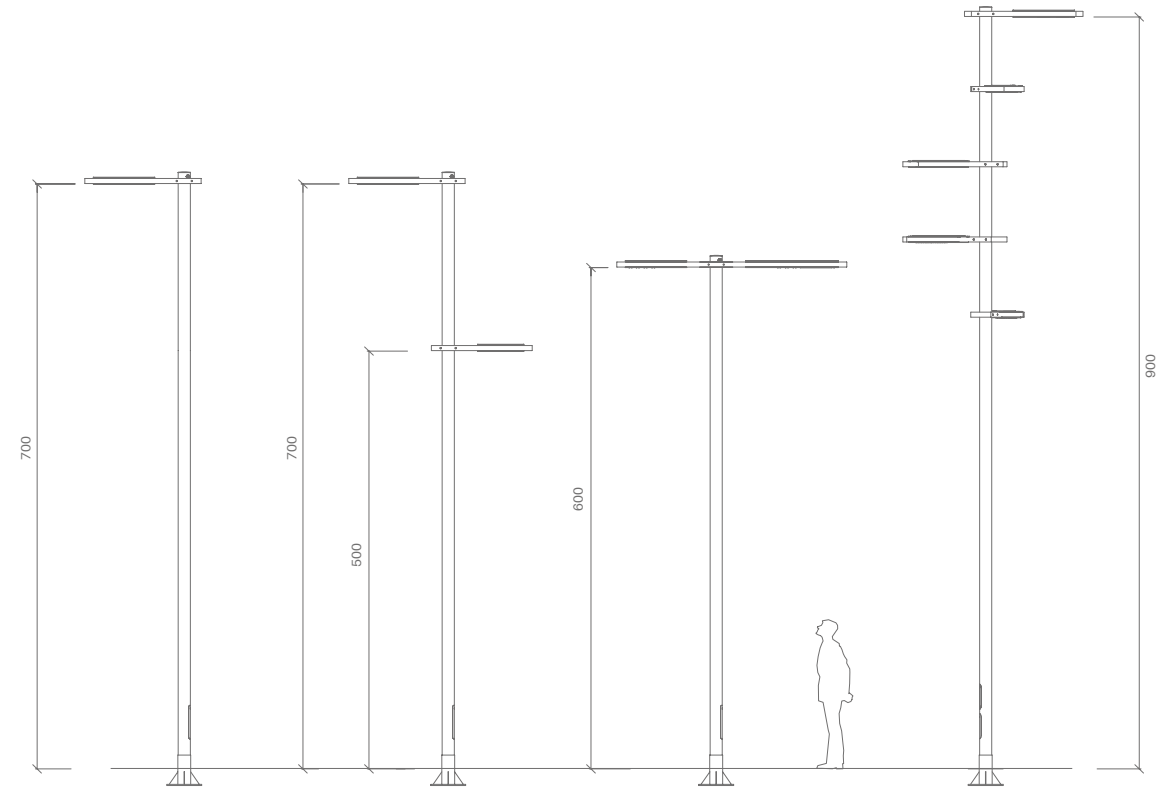

Wide Corta / Short - Aplique / Wall lamp

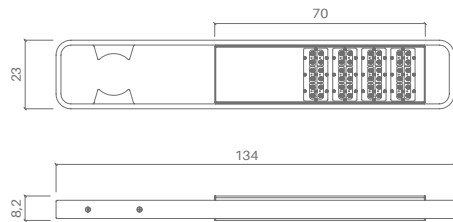

Wide Larga / Long

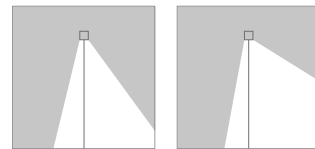

Type III

Type IV

Asymmetrical





018

Wide

Avenida Diputación, Valencia, Spain





Artà, Mallorca, Spain

Wide

021



Sala Beckett



BALI

La farola *Bali* se presenta con la forma más neutra y abstracta resultado de la combinación de una columna y una luminaria de la misma sección prismática de 200 x 100 mm. Adopta la configuración simple, doble escalada y doble simétrica, con una altura máxima de 8 metros.

The *Bali* street lamp has a more neutral, abstract shape, resulting from the combination of a column and a lamp holder with the same prismatic cross section of 200 x 100 mm. It has a single, double and symmetrical step configuration, with a maximum height of 8 metres.

IP66 | IK08 |  |  10 KV¹ |  | UNE-EN 40-50

Propiedades / Properties

¹Opcional / Optional





El sistema de anclaje de luminaria adosada a la columna permite su instalación a diferentes alturas entre 4 y 8 metros.

The system for anchoring the lamp holder to the column means it can be installed at different heights of between 4 and 8 metres.

Luminaria / Luminaire

Potencias / Powers (W)

25 / 50 / 75 / 100

Temperatura color / Color temperature (°K)

3000 Blanco cálido / Warm white

4000 Blanco neutro / Neutral white

Flujo luminoso / Luminous flux (lm)

● 2404 - 9616 Blanco cálido / Warm white

○ 2551 - 10414 Blanco neutro / Neutral white

Eficacia luminaria / Luminous efficiency (lm/W)

81 - 90 Blanco cálido / Warm white

86 - 98 Blanco neutro / Neutral white

Materiales / Materials

● Aluminio pintado negro / Black coated aluminium

Columna / Column

Pesos / Weights

94 kg (4 m); 112 kg (5 m); 130 kg (6 m); 48 kg (7 m)

Dimensiones / Dimensions

7000 x 200 x 100 mm

Espesor / Thickness

4 mm

Refuerzo / Reinforcement

4 mm anillo inferior / Bottom ring

Materiales / Materials

● Acero negro forja / Forge black steel

● Acero galvanizado / Galvanized steel

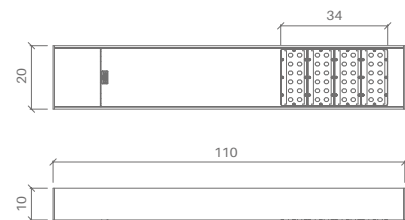
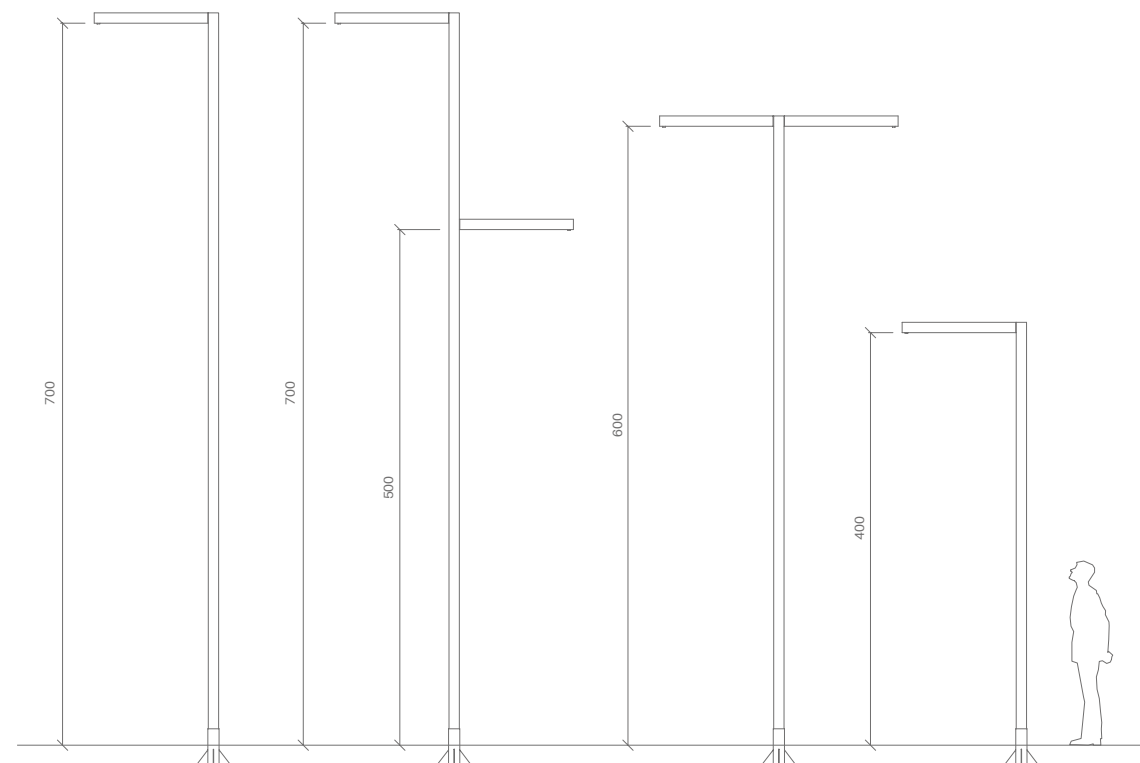

Bali LED



Bali Aplique / Wall lamp

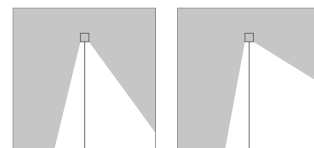

Type III

Type IV

Asymmetrical





030

Bali



Puerto de Ibiza, Spain





Trac
REHABILITACIÓ
D'EDIFICIS S.L.

ALI-BEY



BUS

ADIDAS

ORBIT

NEW

Orbit surge de la necesidad de proponer una luminaria con la máxima funcionalidad y adaptabilidad a diversos entornos urbanos. Para su propuesta formal se ha optado por una forma primaria, compacta y sin aristas, que se concreta en un elipsoide, capaz de armonizar sin estridencias con diversos contextos arquitectónicos y paisajísticos de la ciudad contemporánea.

Orbit was born out of the need to provide a street lamp with maximum functionality that can be adapted to different urban environments. A primary, compact, rounded shape has been used in its formal design, specifically, an ellipsoid capable of effortlessly harmoniously blending with different architectural and landscape contexts in modern-day cities.

⊕ | 10 KV¹ | Proyector LED / LED projector¹ | CE | UNE-EN 40-50

Propiedades / Properties

¹Opcional / Optional





Martorell, Barcelona, Spain

La tecnología LED y su práctico sistema de apertura facilita la operativa de instalación y futuro mantenimiento.

Its LED technology and practical opening system guarantee ease of installation and future maintenance.

Luminaria / Luminaire

Potencias / Powers (W)

25 / 50 / 75 / 100

Temperatura color / Color temperature (°K)

3000 Blanco cálido / Warm white

4000 Blanco neutro / Neutral white

Flujo luminoso / Luminous flux (lm)

● 2822 - 10773 Blanco cálido / Warm white

○ 2994 - 11673 Blanco neutro / Neutral white

Eficacia luminaria / Luminous efficiency (lm/W)

95 - 100 Blanco cálido / Warm white

101 - 110 Blanco neutro / Neutral white

Materiales / Materials

● Aluminio anodizado / Anodized aluminium

Columna / Column

Pesos / Weights

100 kg (4 m); 118 kg (5 m); 136 kg (6 m); 154 kg (7 m);

172 kg (8 m); 190 kg (9 m)

Diámetro / Diameter

100 - 115 - 140 mm

Espesor / Thickness

5 mm

Refuerzo / Reinforcement

4 mm anillo inferior / Bottom ring

Materiales / Materials

● RAL 9006 Acero galvanizado / Galvanized steel

● Acero galvanizado / Galvanized steel

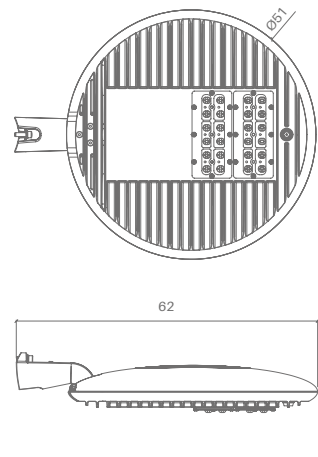

Orbit luminaire

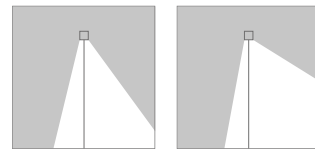

Type III

Type IV

Asymmetrical

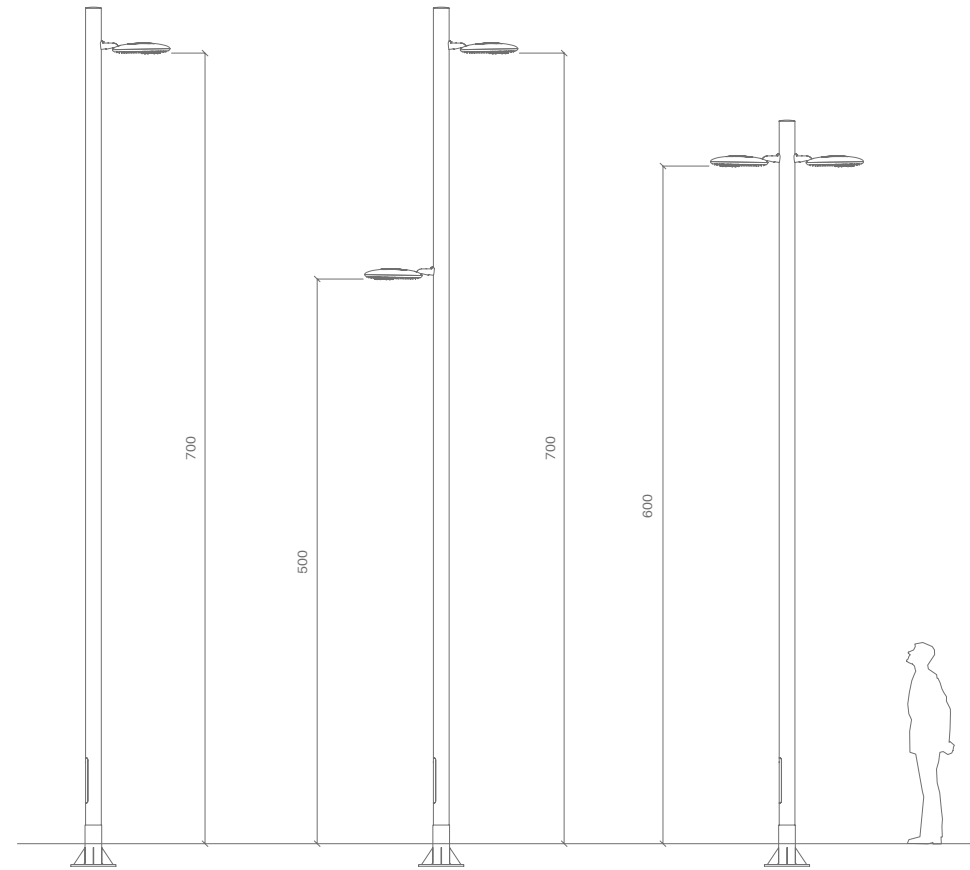

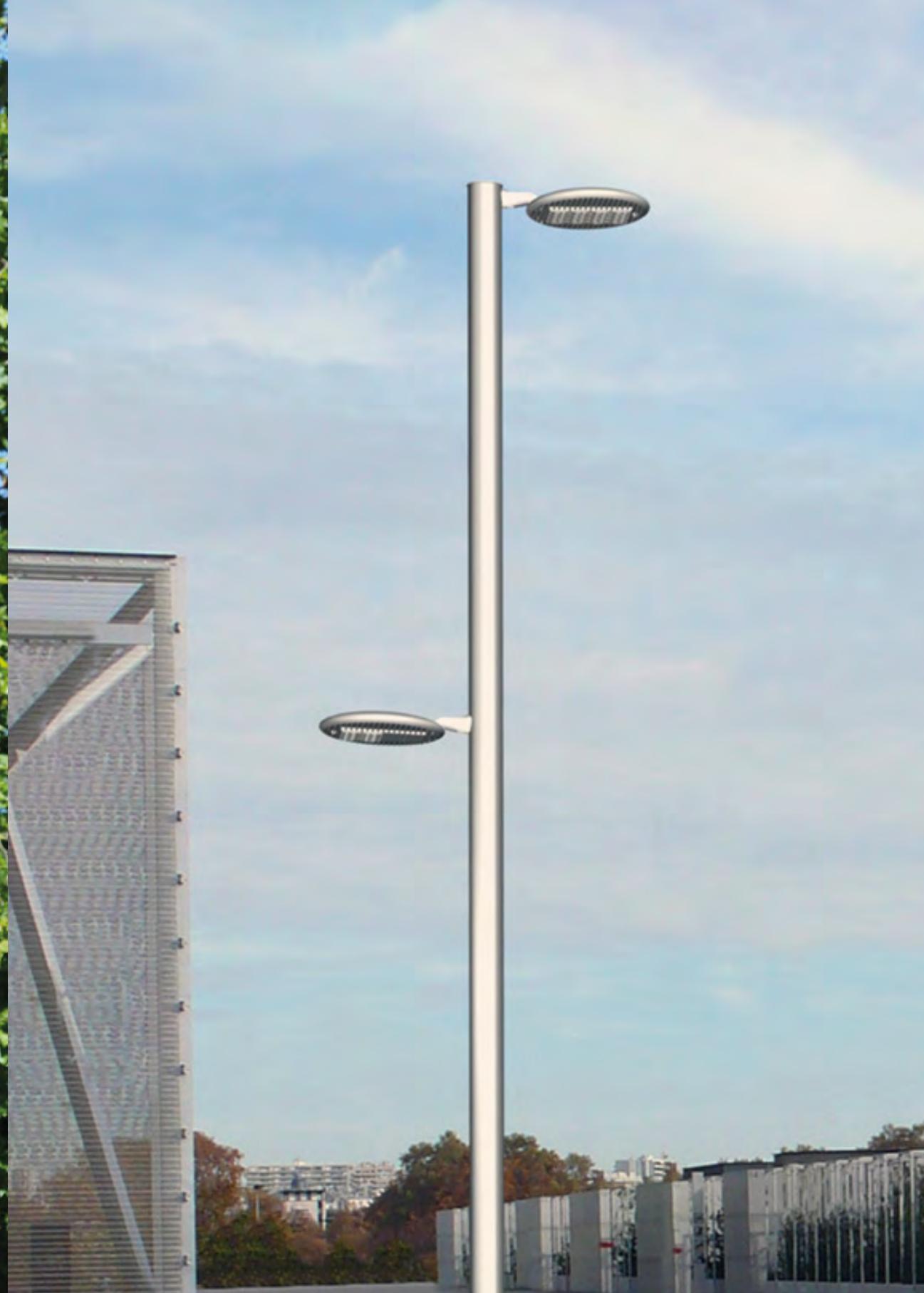

FUL

La serie de columnas de alumbrado *Ful* se compone de seis modelos de sección troncocónica, ligeramente escoradas con una inclinación de 85° y de altura y curvatura variable, que permite una gran libertad de orientaciones y un resultado formal en aparente movimiento.

Ful is a street light series with a conical section and variable curvature, providing considerable freedom to optimise their orientation and create a formal result in apparent movement.

⊕ | ⚡ 10 KV¹ | Proyector LED / LED projector¹ | CE | UNE-EN 40-50

Propiedades / Properties

¹Opcional / Optional





La forma arborescente de la composición permite una buena integración tanto en el medio urbano como el vegetal.

The tree-like composition of this series enhances its integration into both vegetated and urban environments.

Columna / Column

Dimensiones / Dimensions

12 m, 10 m, 9 m, 7 m, 5 m, 4 m

Pesos / Weights

254 kg (12 m), 202 kg (10 m), 202 kg (9 m), 149 kg (7-10 m), 202 kg (7-10 m), 112 kg (5 m), 65 kg (4 m)

Espesor / Thickness

4 mm (Galvanised), 5 mm (Cor-ten)

Refuerzo / Reinforcement

6 mm anillo inferior / Bottom ring

Materiales / Materials

- Acero galvanizado / Galvanized steel
- Acero efecto Cor-ten / Cor-ten effect steel
- Cor-ten / Cor-ten

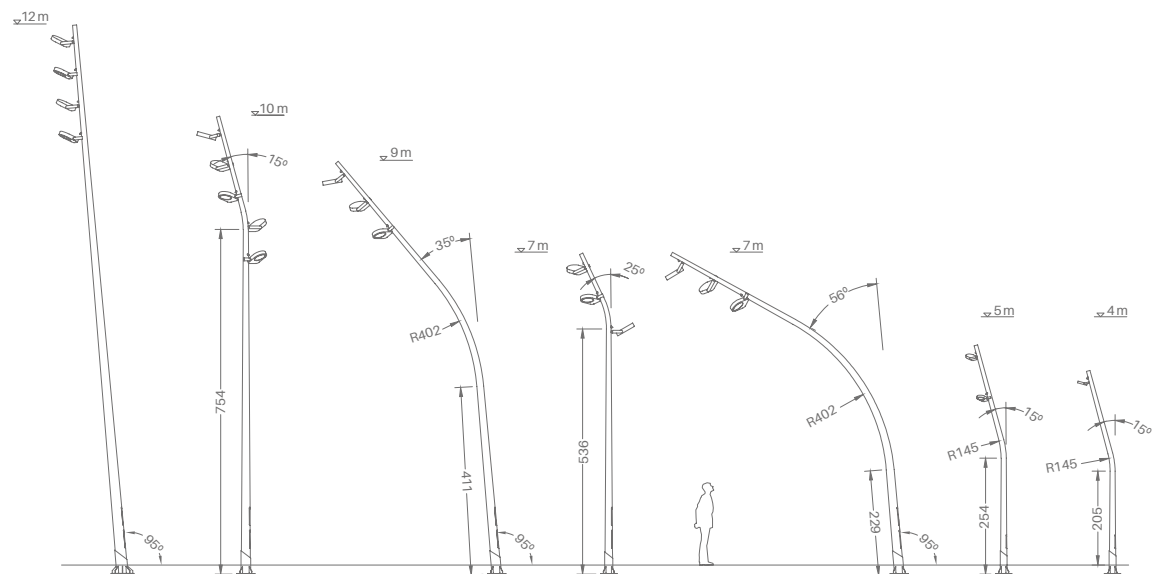

Luminaria / Luminaire

Proyector LED opcional / Optional LED projector

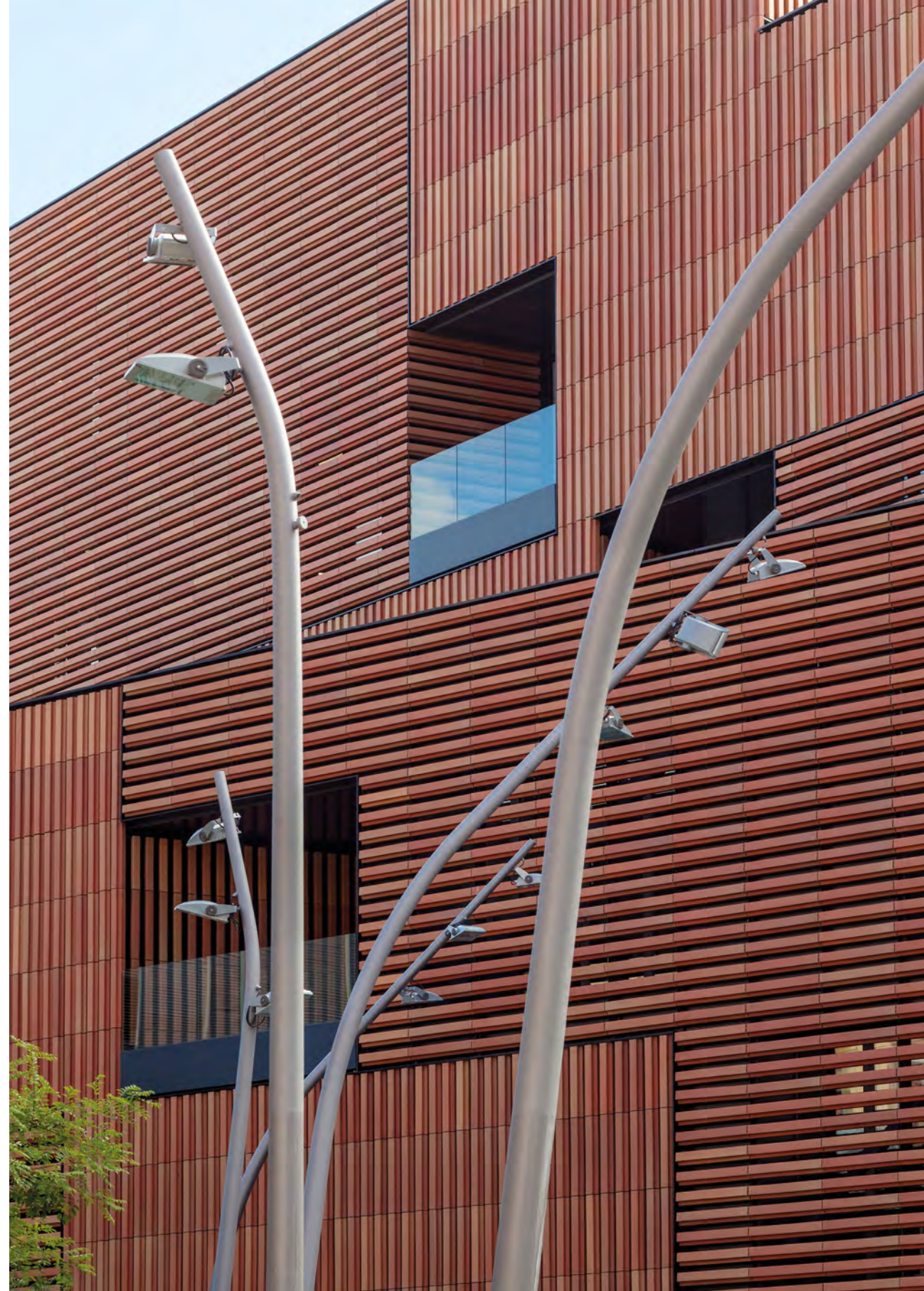

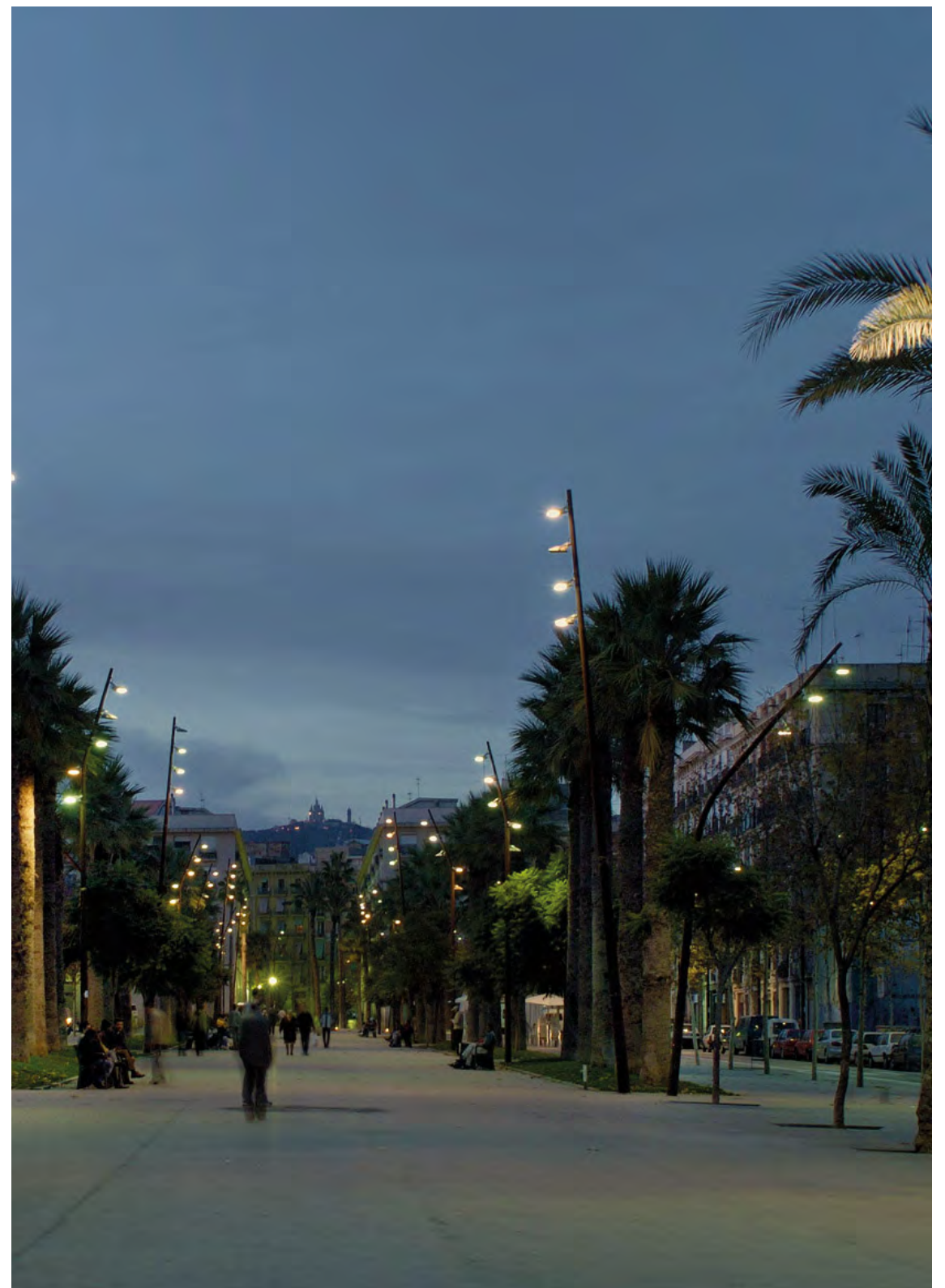

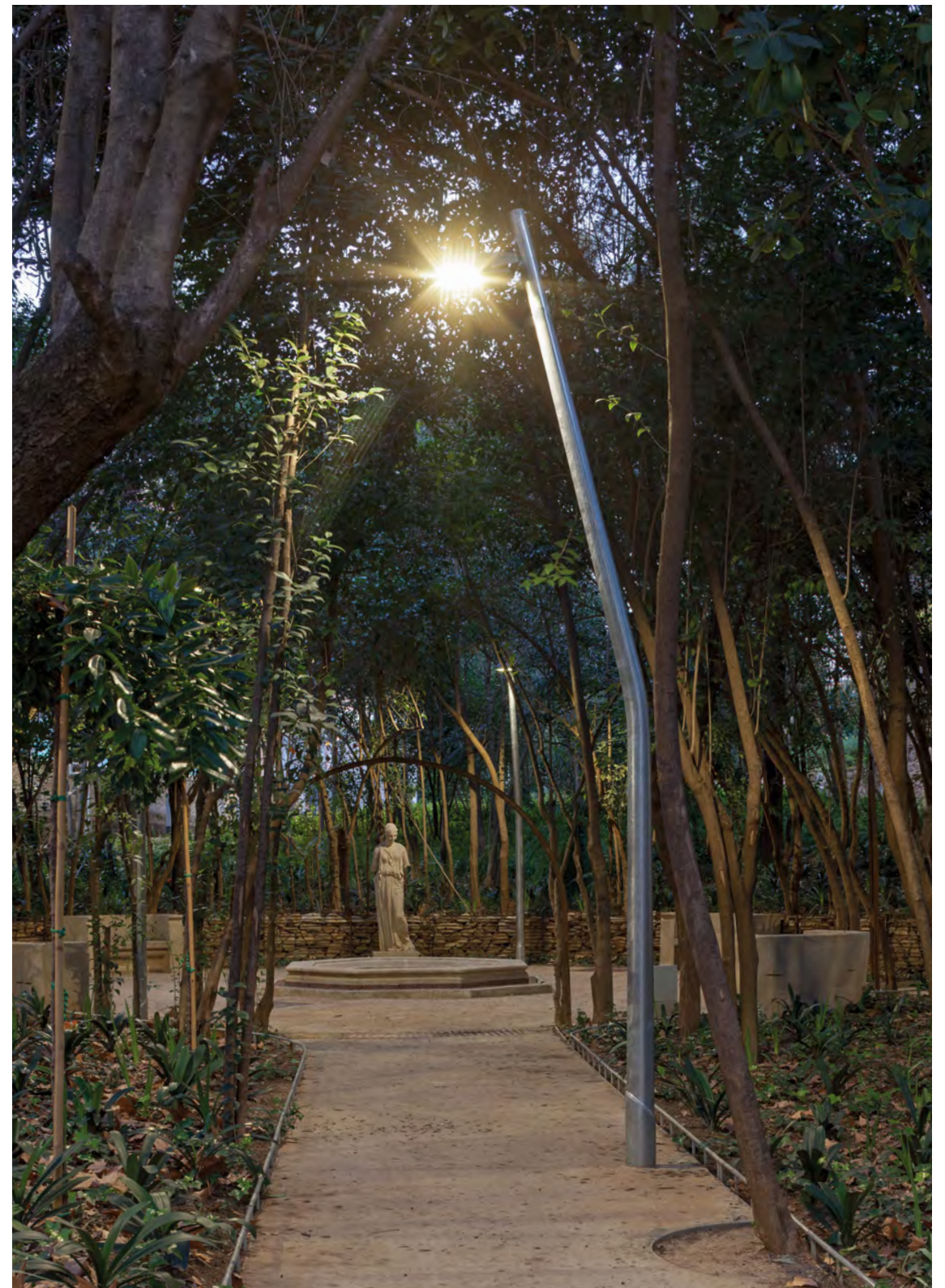



CENTRE D'ART
ESCOLA MASSANA
I DISSENY

KANYA

La serie de columnas *Kanya* está destinada para el alumbrado de grandes áreas, especialmente en aquellas zonas definidas por su condición de límite urbano y gran recorrido cívico. Compuesta por columnas de sección troncocónica, ligeramente escoradas con una inclinación de 85° y altura variable.

The *Kanya* column series is designed for lighting large areas, and in particular, areas defined by their status as city limits and large public areas. The collection is formed by columns with a truncated cone cross section, and with a slight inclination of 85° and a variable height.

⊕ | ⚡ 10 KV¹ | Proyector LED / LED projector¹ | CE | UNE-EN 40-50

Propiedades / Properties

¹Opcional / Optional





Passeig Marítim de la Barceloneta, Barcelona, Spain

Las columnas van equipadas con soporte y salida de cable compatible con cualquier proyector circular con fijación por lira.

The columns are fitted with a support and cable exit compatible with any circular projector anchored with bow shackles.

Columna / Column

Dimensiones / Dimensions

10 m, 12 m, 15 m, 18 m

Pesos / Weights

213 kg (10 m), 284 kg (12 m), 422 kg (15 m), 510 kg (18 m)

Espesor / Thickness

4 mm (Galvanised 10 m, 12 m), 5 mm (Cor-ten)

5 mm (Galvanised 15 m, 18 m)

Refuerzo / Reinforcement

6 mm anillo inferior / Bottom ring

Materiales / Materials

- Acero galvanizado / Galvanized steel
- Acero efecto Cor-ten / Cor-ten effect steel
- Cor-ten / Cor-ten

Luminaria / Luminaire

Proyector LED opcional / Optional LED projector

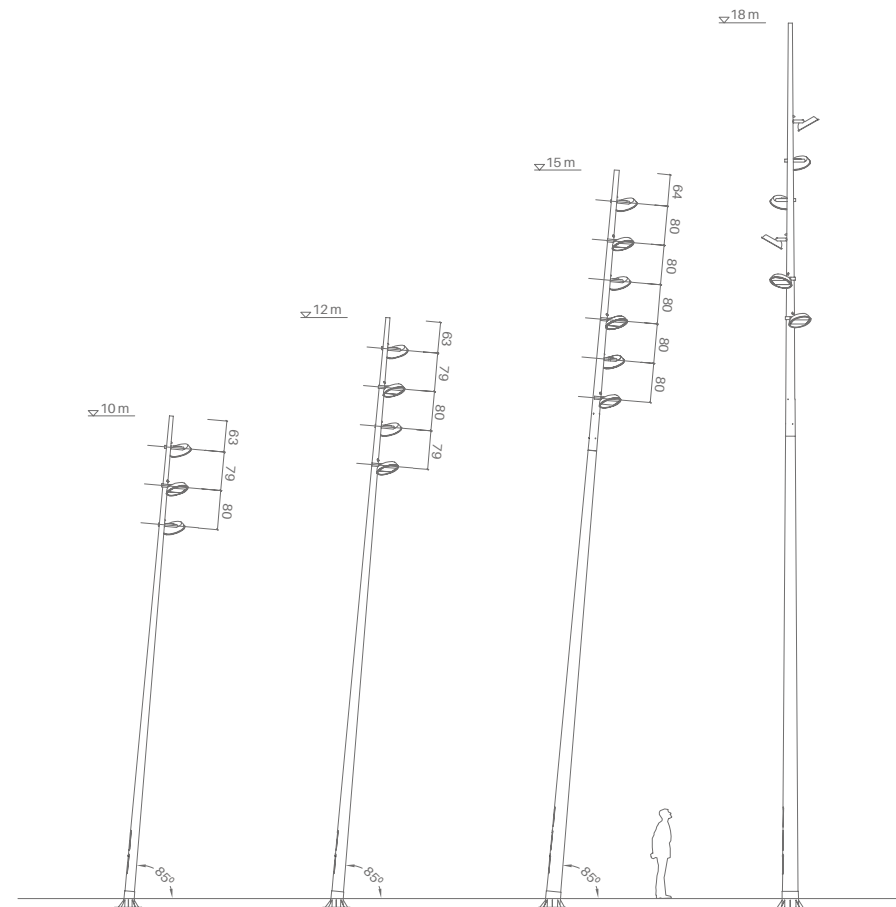







CREAM

NEW

La colección *Cream* incorpora tres elementos de iluminación de geometría prismática, sencilla y minimalista, que se integran fácilmente en el paisaje del jardín público o doméstico. La columna *Cream L*, la baliza *Cream M* y la baliza cúbica *Cream S*.

The *Cream* collection incorporates three lighting elements with a prismatic, simple and minimalist design that easily blend into public parks or home gardens. The column *Cream L*, the beacon *Cream M* and the cubic beacon *Cream S*.

IP66 | IK10 |  |  10 KV¹ |  | UNE-EN 40-50

Propiedades / Properties

¹Opcional / Optional

068

Cream

Cream Arquitectura, 2019





Parc de les Aigües, Barcelona, Spain

Cream

071

Cream nos muestra el vínculo entre dos géneros aparentemente contrapuestos: la prosa y la poesía. Función y emoción.

Cream shows us the link between two apparently opposite genres: prose and poetry. Function and emotion.

Cream S

Dimensiones / Dimensions

25 x 25 x 27,5 (37,5) cm

Pesos / Weights

17 kg

Potencias / Powers

28 W

Flujo luminoso /

Luminous flux

1680 lm

Eficacia luminaria /

Luminous efficiency

60 lm/W

Cream M

Dimensiones / Dimensions

18 x 18 x 74 (86) cm

Pesos / Weights

20 kg

Potencias / Powers

28 W

Flujo luminoso /

Luminous flux

2744 lm

Eficacia luminaria /

Luminous efficiency

98 lm/W

Cream L

Dimensiones / Dimensions

18 x 18 x 320 (340) cm

Pesos / Weights

75 kg

Potencias / Powers

38 W

Flujo luminoso /

Luminous flux

3610 lm

Eficacia luminaria /

Luminous efficiency

95 lm/W

Colección / Collection

Temperatura color / Color temperature (°K)

3000 Blanco cálido / Warm white

4000 Blanco neutro / Neutral white

Materiales / Materials

● Galvanizado negro forja / Galvanized forge black

● Galvanizado dorado / Galvanized gold

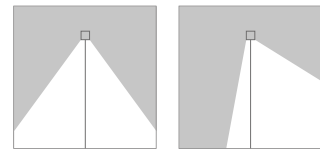
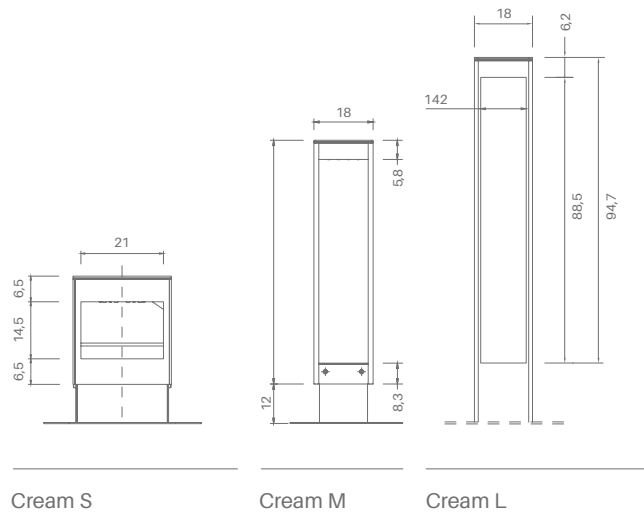
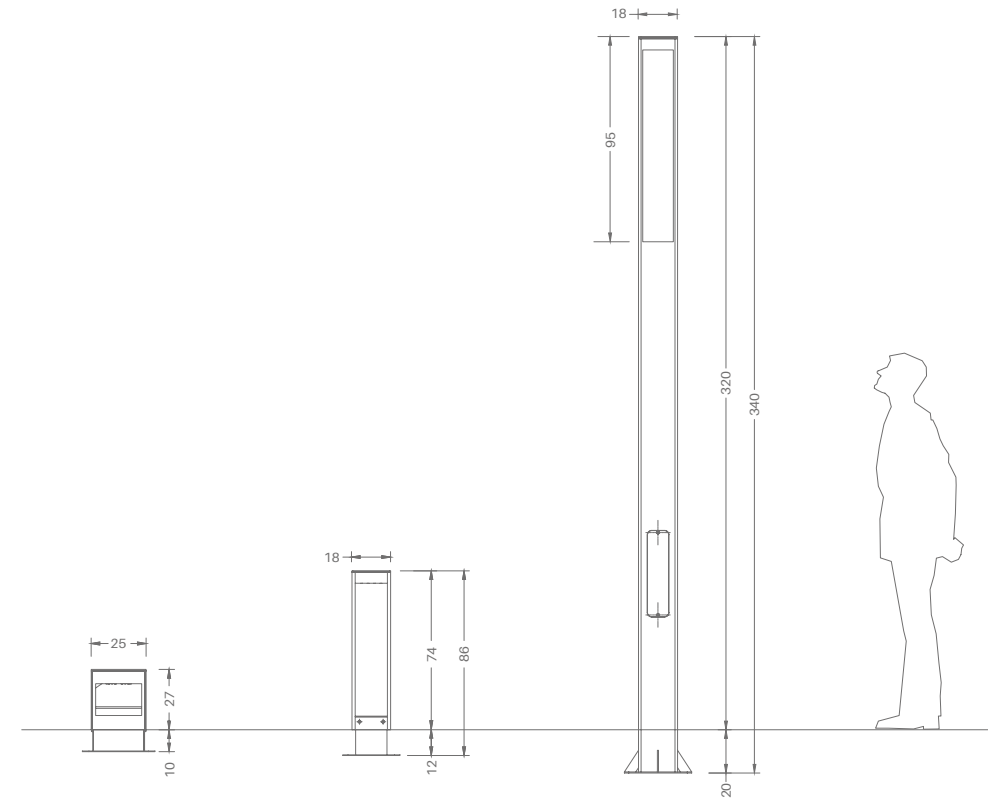

Type SYM

Symmetrical

Type IV

Asymmetrical







PRISMA

Prisma es una colección de dos columnas y una baliza de iluminación ambiental del espacio público que se caracteriza por la esbeltez de su geometría prismática. Se integra fácilmente en el paisaje con dos opciones materiales para la columna: hormigón o acero. La luminaria incorpora un difusor de policarbonato extruido que refracta el flujo luminoso otorgándole, además de la función principal de iluminar, un bello efecto de balizamiento.

Prisma is a collection formed by two columns and a light beacon for public areas, characterised by its thin prismatic geometry. It easily blends into the landscape, with two optional materials for the column: concrete or steel. The lamp holder has an extruded polycarbonate diffuser that deflects the light flow, giving it an attractive beacon-like effect in addition to its main lighting function.

IP66 | IK10 |  |  10 KV¹ |  | UNE-EN 40-50

Propiedades / Properties

¹Opcional / Optional



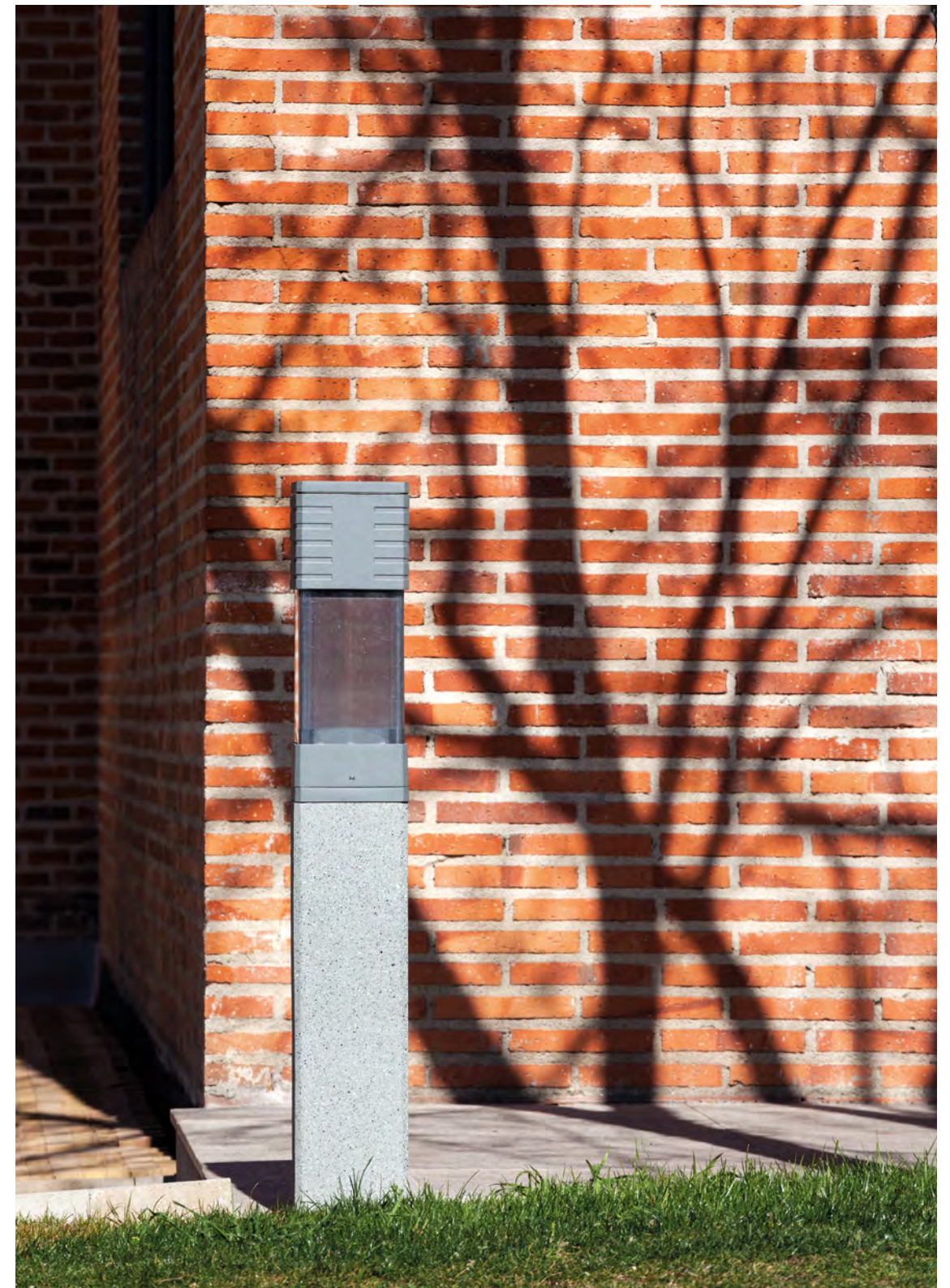

Prisma nace como revisión tecnológica de un modelo clásico del año 1991, inicialmente solo en hormigón y madera.

Prisma was created as a technological review of a classic model from 1991, originally supplied only in concrete and wood.

Prisma Baliza

Dimensiones / Dimensions

66,5 x 16 x 16 cm

Pesos / Weights

50 kg (Concrete), 35 kg (Steel)

Potencias / Powers

17 W

Flujo luminoso /

Luminous flux

2404,21 lm

Eficacia luminaria /

Luminous efficiency

120,5 lm/W

Prisma Media

Dimensiones / Dimensions

232,5 x 16 x 16 cm

Pesos / Weights

170 kg (Concrete), 100 kg (Steel)

Potencias / Powers

38 W

Flujo luminoso /

Luminous flux

4.807,53 lm

Eficacia luminaria /

Luminous efficiency

120,1 lm/W

Prisma Alta

Dimensiones / Dimensions

332,5 x 16 x 16 cm

Pesos / Weights

225 kg (Concrete), 150 kg (Steel)

Potencias / Powers

38 W

Flujo luminoso /

Luminous flux

4.807,53 lm

Eficacia luminaria /

Luminous efficiency

120,1 lm/W

Colección / Collection

Flujo luminoso / Luminous flux (lm)

● 2404 - 9616 Blanco cálido / Warm white

Eficacia luminaria / Luminous efficiency (lm/W)

81 - 90 Blanco cálido / Warm white

Materiales luminaria / Luminaire materials

○ Policarbonato transparente / Clear polycarbonate

● Fundición de aluminio plata / Silver cast aluminium

Materiales columna / Column materials

● Hormigón gris / Grey concrete

● Acero galvanizado plata / Silver galvanized steel

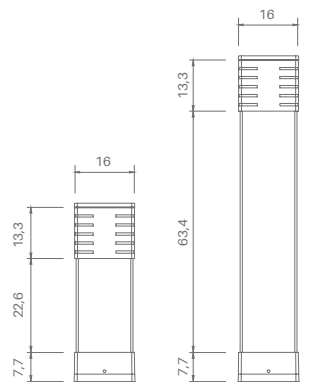
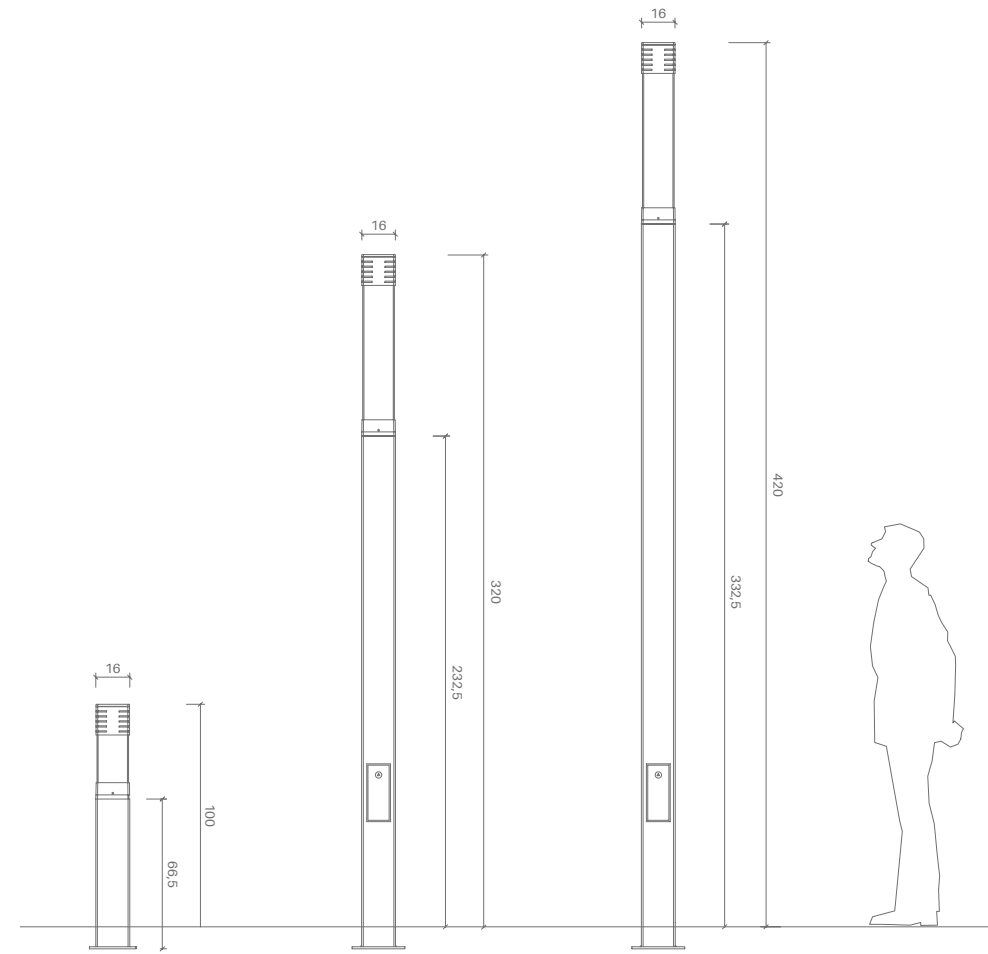

Prisma 17 W

Prisma 38 W

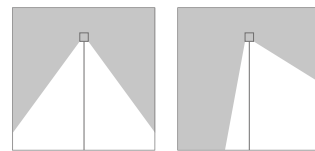

Type SYM

Type IV

Symmetrical

Asymmetrical







INTER

Inter es una farola que se presenta como aplicación del diseño clásico y tradicional de las lámparas domésticas de interior ampliando su escala hasta convertirse en un elemento a escala urbana. Manteniendo el equilibrio entre lo funcional y la expresividad de su luminaria, proyecta un haz de luz circular para iluminar espacios de jardín o de paseo.

Inter is a street lamp that is presented as an application of the classic, traditional design of a domestic lamp, but extending its scale to convert it into an urban scale element. Striking a balance between functionality and the expressive nature of its lamp hold, it projects a circular beam of light to light up garden areas or promenades.

IP66 | IK10 |  |  10 KV¹ |  | UNE-EN 40-50

Propiedades / Properties

¹Opcional / Optional





Passeig Marítim de Llafranc, Girona, Spain

Inter

La farolas *Inter* han sido recientemente instaladas en el Paseo Marítimo de Calella de Palafrugell, en Girona.

The *Inter* lamps were recently installed amidst the pines of the Sea Promenade of Llafranc in Calella de Palafrugell, Girona.

Luminaria / Luminaire

Dimensiones/ Dimensions

Ø91 x 48 cm

Peso / Weight

27 kg

Potencias / Powers (W)

70 / 100 / 150

Flujo luminoso / Luminous flux (lm)

● 2404 - 9616 Blanco cálido / Warm white

Eficacia luminaria / Luminous efficiency (lm/W)

81 - 90 Blanco cálido / Warm white

Materiales / Materials

- LDPE blanco / White LDPE
- LDPE gris plata / Silver grey LDPE
- LDPE negro / Black LDPE

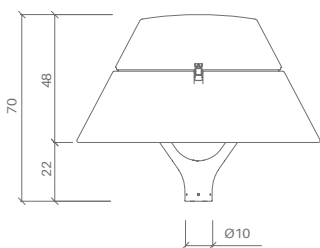
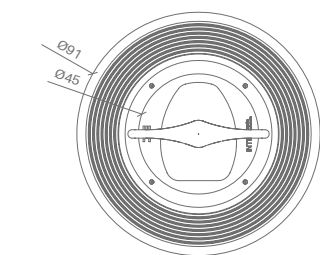

Inter luminaire

Columna / Column

Pesos / Weights

64 kg (5 m); 74 kg (6 m)

Diámetro / Diameter

100 mm

Espesor / Thickness

4 mm

Refuerzo / Reinforcement

4 mm anillo inferior / Bottom ring

Materiales / Materials

- Acero galvanizado plata / Silver galvanized steel
- Acero galvanizado / Galvanized steel

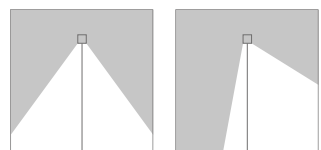

Type SYM

Symmetrical

Type IV

Asymmetrical

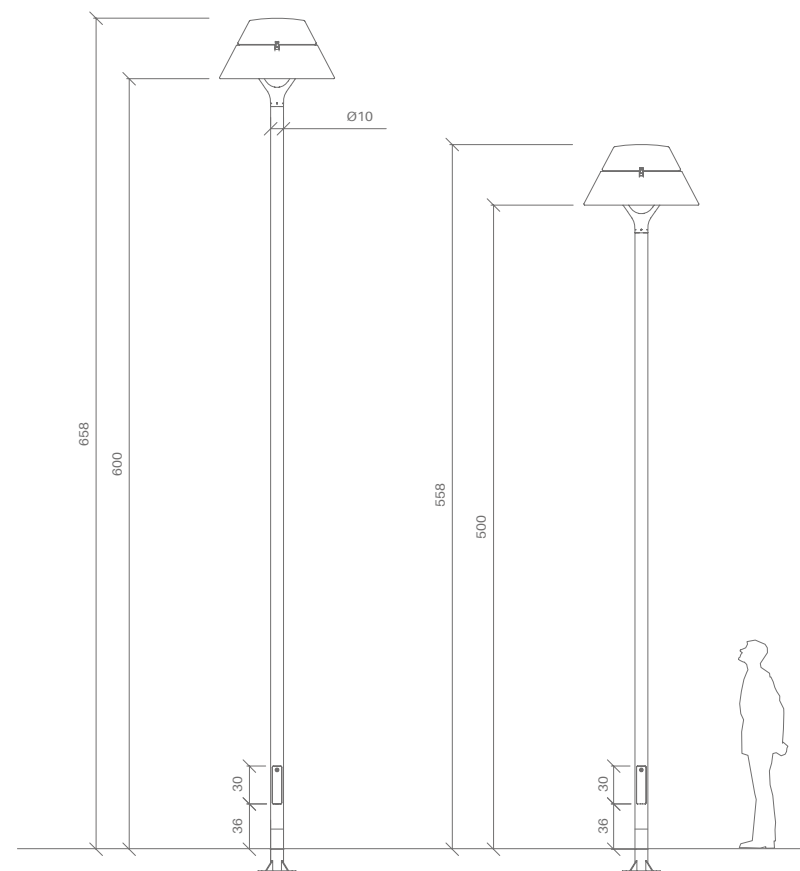





LOLA

La farola *Lola* se aparta de las propuestas tradicionales, manteniendo el equilibrio entre lo funcional y la expresividad de su luminaria envolvente. Formada por un cilindro de plástico rotomoldeado de color blanco, que se suspende por su generatriz y de inequívoco origen.

Lola is a street lamp that has nothing to do with traditional proposals and maintains a balance between functionality and the expressive nature of the lamp holder. A white plastic rotary moulded cylinder suspended from its generator of an unequivocal origin.

IP66 | IK08 |  |  10 KV¹ |  | UNE-EN 40-50

Propiedades / Properties

¹Opcional / Optional





Paseo Galió, Mallorca, Spain

Lola traslada un concepto de iluminación clásica del interior al exterior, integrándose en diferentes contextos urbanos.

Lola transmits a classic lighting concept from indoors to outdoors, allowing it to be integrated in different urban contexts.

Luminaria / Luminaire

Dimensiones/ Dimensions

Ø74,5 x 34,5 cm

Peso / Weight

29 kg

Potencias / Powers (W)

25 / 50 / 75

Flujo luminoso / Luminous flux (lm)

● 2404 - 9616 Blanco cálido / Warm white

○ 2551 - 10414 Blanco neutro / Neutral white

Eficacia luminaria / Luminous efficiency (lm/W)

81 - 90 Blanco cálido / Warm white

86 - 98 Blanco neutro / Neutral white

Materiales / Materials

○ LDPE blanco / White LDPE

● LDPE amarillo mostaza / Mustard yellow LDPE

● LDPE azul cielo / Sky blue LDPE

Columna / Column

Pesos / Weights

102 kg (6 m); 116 kg (7 m)

Diámetro / Diameter

100 mm

Espesor / Thickness

4 mm

Refuerzo / Reinforcement

4 mm anillo inferior / Bottom ring

Materiales / Materials

● Acero galvanizado plata / Silver galvanized steel

● Acero galvanizado / Galvanized steel

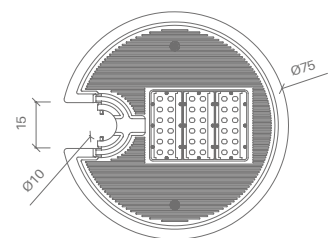
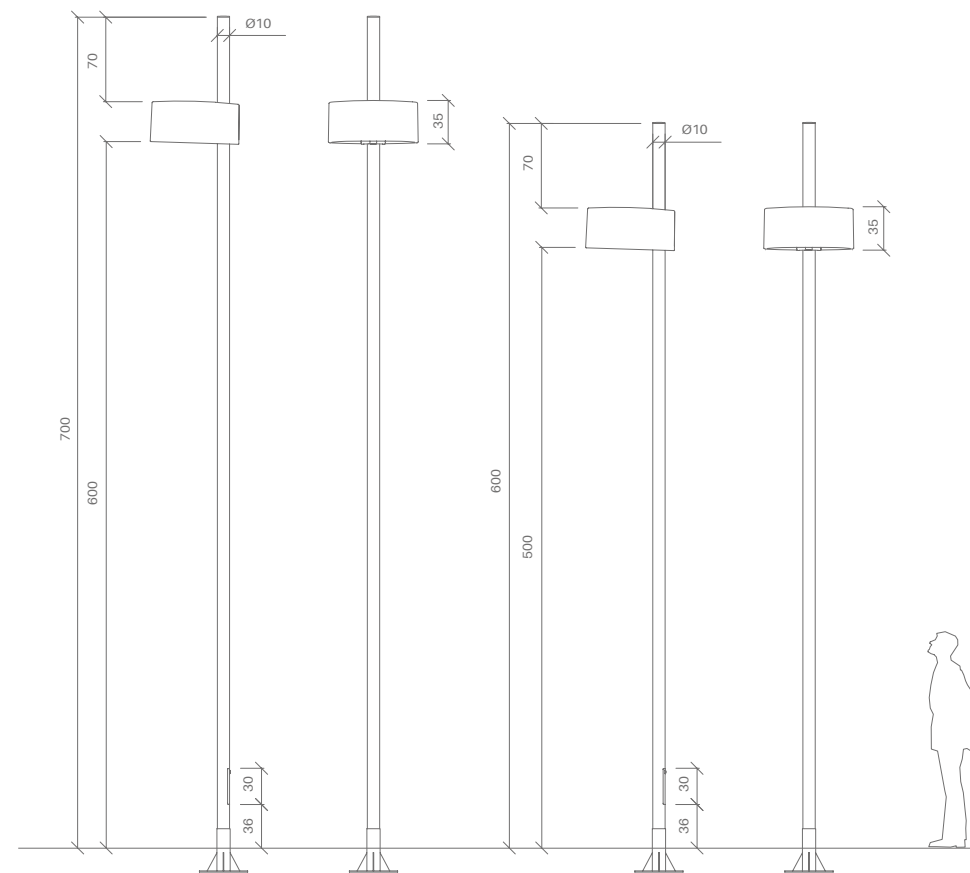

Lola luminaire

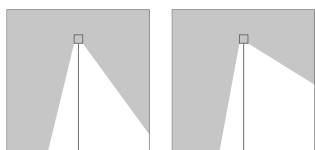

Type III

Type IV

Asymmetrical

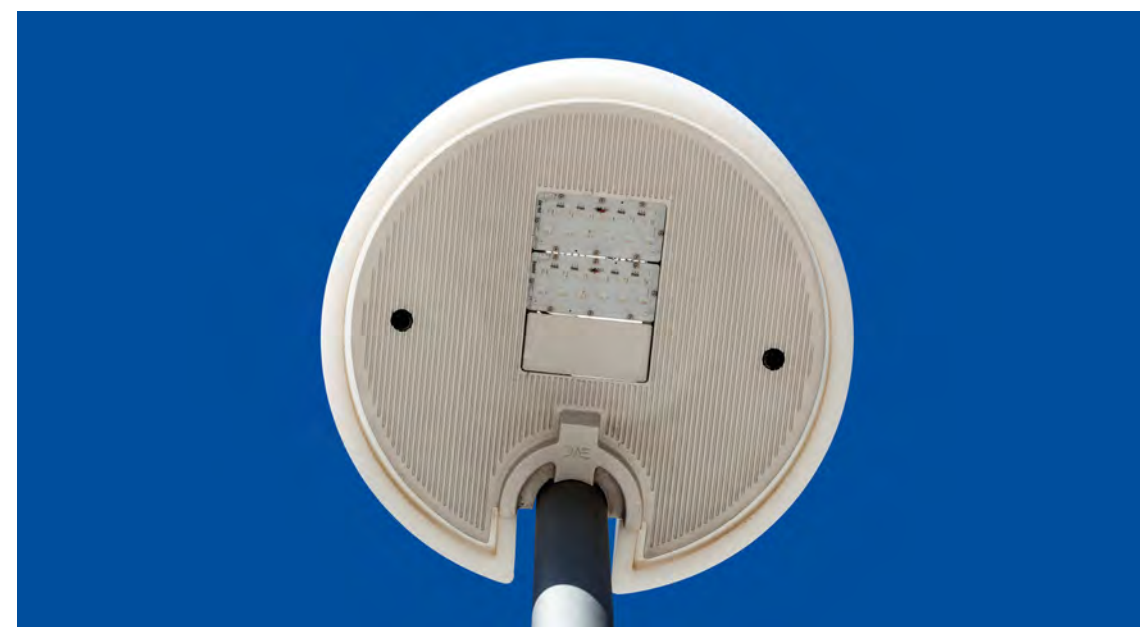





Paseo Marqués de la Hermida, Santander, Spain

MOTA

Mota es un límite-baliza de hormigón de gran sobriedad y simplicidad formal con una luminaria encastada para la iluminación de caminos y delimitar el espacio público sin contaminación lumínica hacia el hemisferio superior celeste.

Mota is a concrete marker and beacon with an austere design and a formal simplicity. It has a recessed lamp holder for lighting paths and delimiting public areas, without generating light dispersion in the upper hemisphere.

LED | 20 W |  |  10 KV¹ | 

Propiedades / Properties

¹Opcional / Optional



El volumen de hormigón facetado en forma de “L” invertida, incorpora un espacio para la integración de la luminaria.

The faceted concrete volume in the shape of an inverted “L” includes a space for housing the lamp holder.

Baliza / Beacon

Dimensiones / Dimensions

55 x 55 x 70 cm

Peso / Weight

190 kg

Materiales / Materials

Hormigón / Concrete

Colores / Colors

- Gris / Grey
- Negro / Black
- Blanco / White
- Gris CA / CA Grey
- Rojo / Red
- Beige / Beige

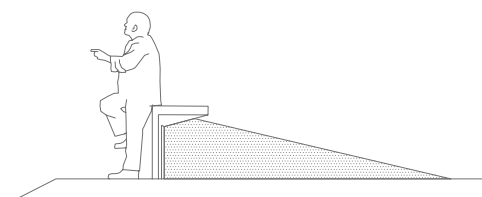
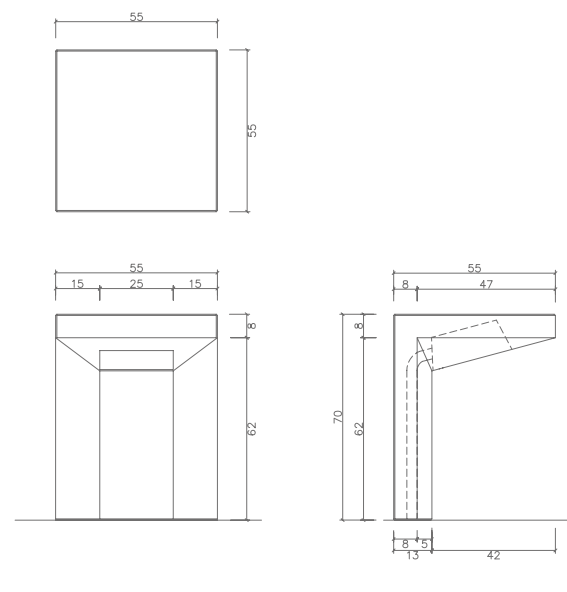

Geometría / Geometry

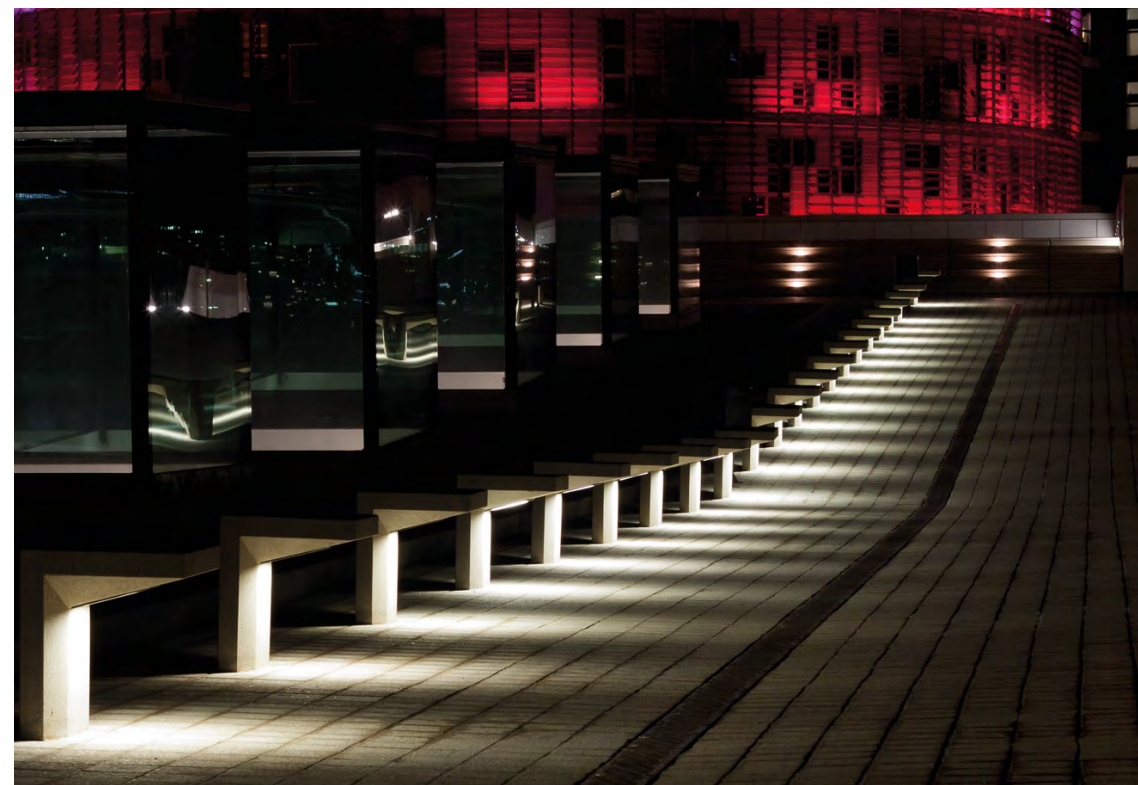

QUAKE

Quake es un límite-baliza de hormigón en forma de cubo escorado adaptado a la ergonomía de las personas, en el que la luz rasante se escapa por la entrega de una de sus caras con el suelo, para la iluminación de caminos y delimitar el espacio público sin contaminación lumínica hacia el hemisferio superior celeste.

Quake is a concrete marker and beacon in the shape of an inclined cube adapted to the ergonomics of people in which the grazing light escapes through contact of one of the sides with the ground, lighting paths and delimiting public areas without generating light dispersion to the upper hemisphere.

LED | 6 W |  |  10 KV¹ | 

Propiedades / Properties

¹Opcional / Optional



Responde al encargo de hacer un elemento de hormigón que funcione como asiento y bolardo, con iluminación LED que alumbré el espacio por la noche.

It responds to the request to create a concrete element that would function as a seat and a bollard, with LED lighting to illuminate the area at night.

Baliza / Beacon

Dimensiones / Dimensions

54 x 45 x 45 cm

Peso / Weight

240 kg

Materiales / Materials

Hormigón / Concrete

Colores / Colors

- Gris / Grey
- Negro / Black
- Blanco / White
- Gris CA / CA Grey
- Rojo / Red
- Beige / Beige

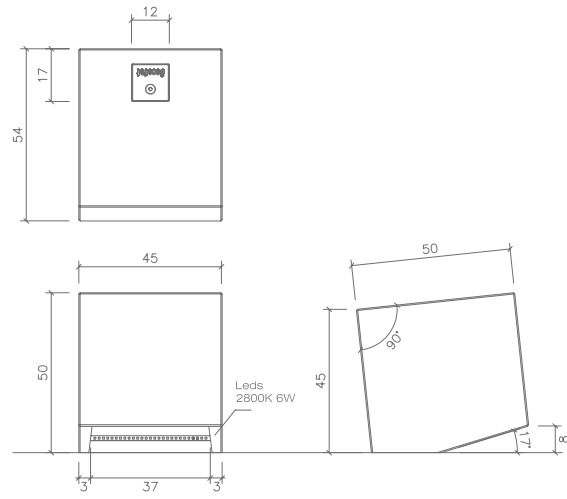

Geometría / Geometry



Paseo Galió, Mallorca, Spain

Quake

MORELLA

La baliza *Morella* de inequívoca cualidad urbana, actúa como límite y referencia luminosa en sutil complicidad con los transeúntes. La continuidad de dos superficies cilíndricas de radios desiguales genera un objeto de robusta apariencia y visualidad reversible, según reciba la luz del sol o proyecte él mismo un haz de luz baja a partir del crepúsculo.

The *Morella* beacon, of unequivocal urban quality, acts as a reference point and luminous reference in a somehow subtle complicity with passers-by. The continuity of two cylindrical surfaces with different radii generates a precise, complex object with a deceiving appearance and a reversible visibility, depending on whether it receives sunlight or projects its own light beam after dusk.

Tubos fluorescentes / Fluorescent tubes¹ | 18 W |  |  10 KV¹ | 

Propiedades / Properties

¹Opcional / Optional



La baliza *Morella* forma parte del conjunto de la serie que debe su nombre al hecho de que fueron diseñados para el espacio público de la ciudad de Morella.

The *Morella* beacon is part of the series that received its name due to being designed for use in the public space of the city of Morella.

Baliza / Beacon

Dimensiones / Dimensions

Ø28 x 90 cm

Peso / Weight

28 kg

Materiales / Materials

● Acero efecto Cor-ten / Cor-ten effect steel

● Cor-ten / Cor-ten

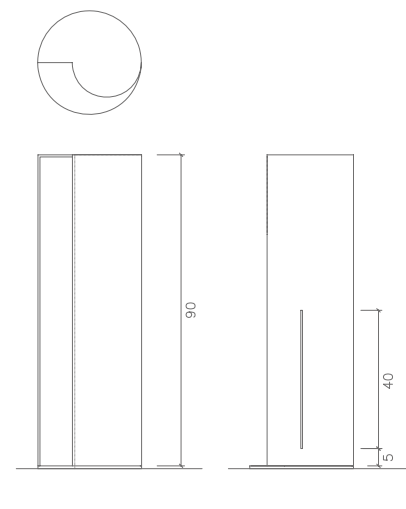

Geometría / Geometry



Certificaciones / Certifications

Escofet 1886, S.A trabaja con criterios y principios de respeto al medioambiente, la seguridad y la salud en el trabajo, además de fuertes estándares de calidad en la gestión de todos los procesos de producción y gestión de la empresa. Forma parte de nuestra cultura de empresa y como filosofía, nos ha llevado a integrar dentro de nuestra organización los estándares y las certificaciones que así lo garantizan.

Escofet 1886, S.A applies criteria and principles based on respect for nature, health and safety at work and strict quality standards in all its management and production processes. It forms part of our company philosophy, and as such, has led us to incorporate standards and certifications in our organisation in order to guarantee it.



CE Todos nuestros productos cumplen con las Directivas y Normativas Europeas apropiadas, tales como la Directiva de compatibilidad electromagnética (EMC) y la Directiva de baja tensión.

CE All our products comply with the appropriate European Directives and Regulations, such as the Electromagnetic Compatibility Directive (EMC) and the Low Voltage Directive.

Símbolos / Symbols



CLASE I Indica el grado de protección contra choques eléctricos. Además de incorporar un aislamiento funcional en todas sus partes, tiene conexión a tierra.

CLASS I Classification according to degree of protection against electric shock. In addition to all parts being electrically insulated, it has a connection to earth.



Incorpora un dispositivo de protección contra sobretensiones de hasta 10 KV. Cuando el indicador LED verde del dispositivo se apaga, el componente protector debe ser reemplazado.

It incorporates an overvoltage protection device up to 10 KV. These protective components are fitted with a green LED indicator. When the LED goes out, the protective component has to be replaced.



Indica el grado de protección de las luminarias a la penetración de sólidos y líquidos. Este grado se expresa mediante las siglas IP seguidas de un número de dos dígitos que expresa el grado de protección.

The IP measures the degree of luminaire protection against intrusion of solids and liquids. It is expressed by the initials IP followed by two digits that stand for the degree of protection.



Indica el grado de protección proporcionado por la envolvente contra los impactos mecánicos nocivos, salvaguardando así los materiales o equipos que haya en su interior.

This indicates the degree of protection provided by enclosures for electrical equipment against harmful external mechanical impacts.

1988 — 2020





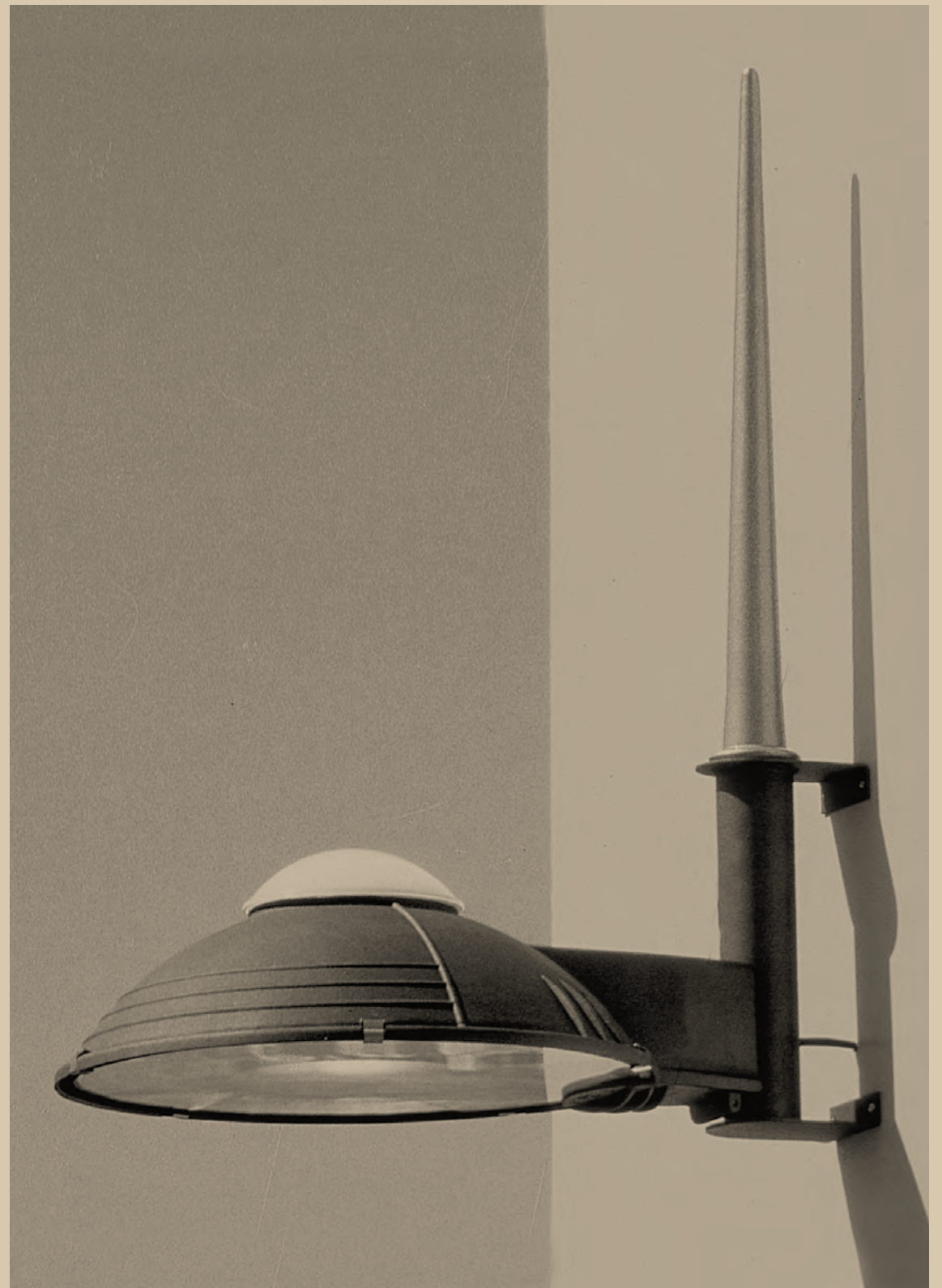























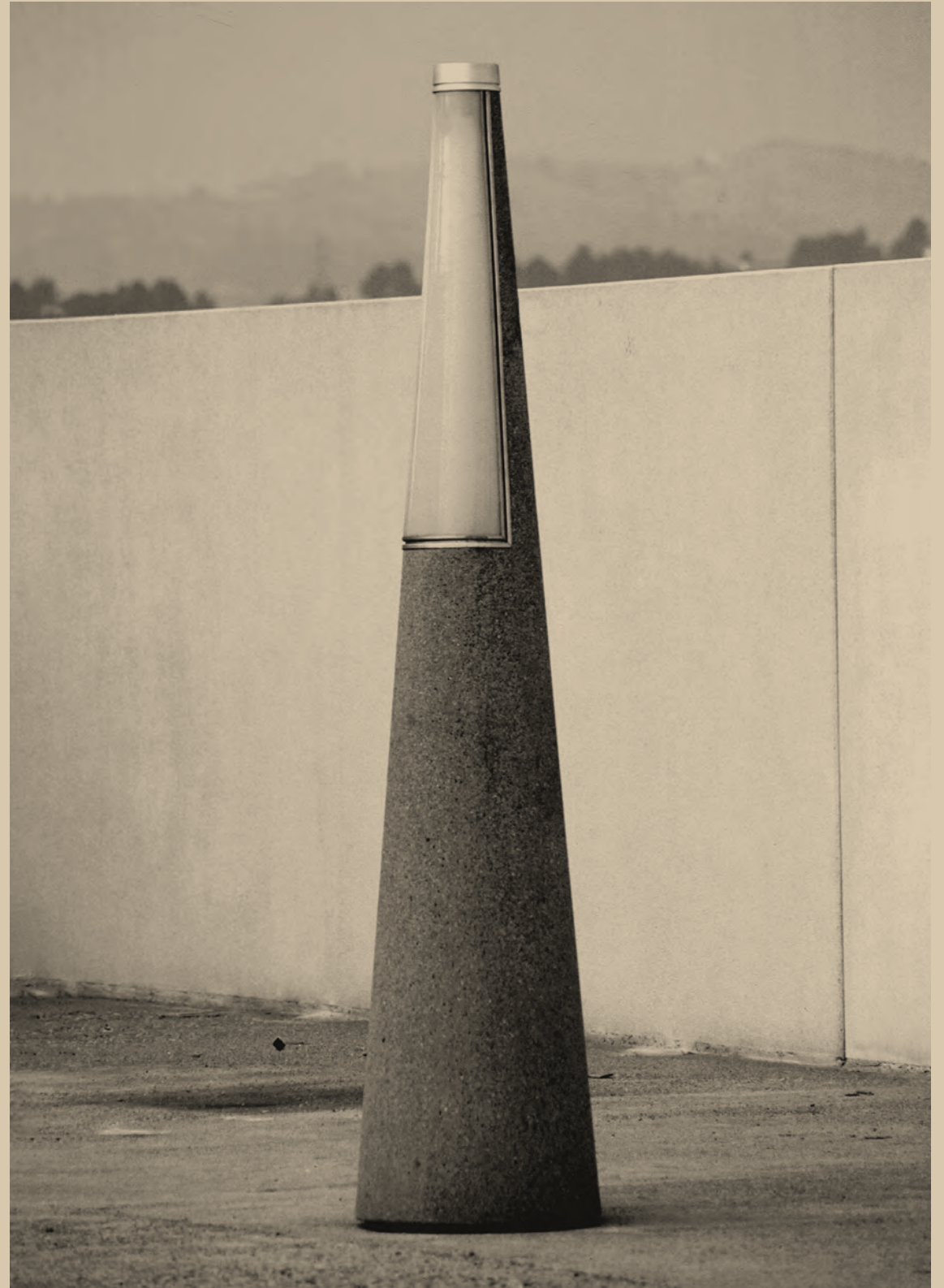

















Los nombres, marcas y modelos industriales de los productos han sido depositados en los registros correspondientes. La información técnica facilitada por *Escofet* sobre sus productos puede sufrir modificación sin previo aviso.

The names, trademarks and industrial models of the products have been logged in the corresponding registers. The technical information provided by *Escofet* about its products can be modified without prior notice.

Escofet 1886 S.A
Oficina central y producción/
Head office and production

Montserrat, 162
E 08760 Martorell
Barcelona - España
T. 0034 937 737 150
F. 0034 937 737 151

info@escofet.com
www.escofet.com